



SAM
inwest



WYWAŻARKI DO KÓŁ OSOBOWYCH

CENNIK 07.2026



**PIERWSZY AUTORYZOWANY DYSTRYBUTOR I
PRZEDSTAWICIEL MARKI CORGHI W POLSCE**

Wersja
PL

O MARCE

CORGHI (1954) jest największym producentem sprzętu do obsługi kół. Obecna gama oferowanych produktów zawiera montażownice automatyczne, wyważarki do kół, urządzenia do ustawiania geometrii kół, podnośniki, linie diagnostyczne, inny sprzęt diagnostyczny oraz urządzenia dodatkowe. Wraz z partnerami, Corghi posiada największą na świecie sieć dystrybucji sprzętu do obsługi samochodów. Swoim zasięgiem obejmuje 137 krajów, posiada ponadto swe filie w Niemczech, Meksyku i Chinach, a w 2009 roku została otwarta filia w Stanach Zjednoczonych. Od roku 2018 zmieniono nazwę firmy na Nexion SPA. Marka Corghi i siedziba pozostała bez zmian.

MISJA FIRMY

Klienci są najważniejsi – naszym najważniejszym priorytetem jest zadowolenie klienta z jakości, dystrybucji i innowacyjności produktów.

Całościowe i kompleksowe rozwiązania we wszystkim co robimy – jest kluczem do budowania silnych relacji partnerskich ze współpracownikami, klientami, dostawcami a naszą firmą.

Ciągłe udoskonalanie – jest bardzo ważnym aspektem naszej działalności.

Innowacyjność dla rozwoju – kreatywne i całościowe rozwiązania prowadzą nas do rozwoju.

Najlepsze talenty dla zespołu – nasza kadra jest wysoko wykwalifikowana, kreatywna, przedsiębiorcza i wie jak osiągnąć najlepsze efekty.

INNOWACYJNOŚĆ

Corghi może także poszczycić się nagrodami za innowacyjność technologiczną w swoim sektorze, przyznanymi przez niezależne organizacje certyfikujące i doceniające ciągle starania i wysiłki w osiągnięciu rezultatów w innowacyjności. Innowacyjności, która pozwala specjalistom z branży oponiarskiej oraz branży automechaniki na pełny profesjonalizm w swej dziedzinie w odpowiedzi na wszelkie nowinki techniczne związane z projektowaniem samochodów i opon.

CENNIK

Producent zastrzega sobie prawo do zmiany parametrów swoich produktów w dowolnym czasie. Informacje zawarte w niniejszym cenniku nie są prawnie wiążące i nie stanowią oferty handlowej, w tym w rozumieniu art. 66 § 1 Kodeksu cywilnego. Zdjęcia mają charakter poglądowy i mogą różnić się od oryginału. Zastrzegamy sobie prawo do zmian cen sprzedaży w przypadku, gdy wartość kursu sprzedaży EUR w NBP przekroczy 4,8000 PLN/€. Kopiowanie oraz jakiegokolwiek modyfikowane zabronione. Cennik SAMiNWEST ważny od 10. 07. 2026 do ukazania się nowej wersji .

*Gwarantujemy najlepsze ceny Marki
CORGHI w kraju. Wysokie rabaty
dla każdego klienta na maszyny
najwyższej jakości.
Znajdź lepszą ofertę na
rynku a sprostamy każdej*

*Ceny podane w niniejszym cenniku są
cenami katalogowymi netto bez rabatu. Standardowy
rabat to **-25%** odliczany od cen katalogowych netto.*

*Skontaktuj się z nami aby otrzymać coś
więcej i dowiedzieć się o naszych promocjach*

Tel. 601 555 541



Wyjaśnienia ikon i opisy funkcji do nich przypisanych



1 SYSTEM OSZCZĘDZANIA CIĘŻARKÓW

Jest to oprogramowanie zawierające system oszczędzania ciężarków minimalizujący czas pracy i ilość aplikowanych ciężarków zmniejszając koszty i zagrożenie dla środowiska.



2 EKRAN DOTYKOWY

Graficzny interfejs, oraz dotykowa technologia ułatwiają i przyspieszają pracę i wybór programów.



3 WSKAŹNIK APLIKOWANIA CIĘŻARKÓW

Ciężarki klejone mogą być łatwo aplikowane w miejscu wskazanym przez wskaźnik laserowy.



4 AUTOMATYCZNE MOCOWANIE KOŁA

Nowy elektromechaniczny system mocowania skracający czas i zwiększający precyzję centrowania koła.



5 INTELIGENTNE POZYCJONOWANIE

Specjalne narzędzie diagnostyczne. Po zbadaniu wszystkich kół pojazdu pod kątem zużycia bieżnika, starcia kierunkowego czy niedowagi system proponuje odpowiednie rozłożenie kół na pojeździe zwiększające komfort i bezpieczeństwo jazdy. Test drogowy bez testu obciążeniowego.



6 OŚWIETLENIE LED

Ułatwia pracę przy czyszczeniu miejsca aplikacji ciężarka i procesu klejenia.



7 KOMPLETNA DIAGNOSTYKA KOŁA

Diagnostyczny program automatycznie mierzy następujące parametry za pomocą sonaru:

- precyzyjny pomiar bicia koła we wszystkich płaszczyznach oraz kalkulacja optymalnego spasowania felga-opona, rozwiązujący większość problemów wibracji powodowanych ogumieniem.
- ścięcie opony, który powoduje że pojazd jest stale ciągnięty w jedną stronę w czasie jazdy w linii prostej
- głębokość bieżnika.



8 OSZCZĘDNOŚĆ MIEJSCA

Pochylny przód maszyny dla łatwiejszego dostępu do wnętrza koła, oraz osłona koła zaprojektowana tak, aby zminimalizować potrzebne miejsce, tzw. „Zero Space”.



9 PRZYCIŚK WIELOFUNKCYJNY I STÓŁ NA CIĘŻARKI

Stół na ciężarki jest ergonomiczny i funkcjonalny, może pomieścić różne rodzaje ciężarków oraz narzędzi. Przycisk wielofunkcyjny jest prosty i szybki oraz ułatwia wybór programów.



10 W PEŁNI AUTOMATYCZNA

Nie wymaga żadnych operacji ręcznych od operatora.

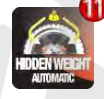

11 TRYB UKRYTEGO CIĘŻARU

Nowy program ukrytego ciężaru tzw. "Hidden Weight" do podziału ciężarków na dwie równoważne wagi ukryte za szprychami. Całkowicie automatyczna operacja.



12 WYKRYWANIE WYMIARÓW KÓŁ

cyfrowy miernik do akwizycji średnicy i odległości z funkcją FSP (Fast Selection Program) i nowym zintegrowanym wskaźnikiem LaserBlade: funkcja FSP automatycznie aktywuje program wyważania, unikając wyboru za pomocą klawiatury, podczas gdy wskaźnik LaserBlade (wewnątrz ramienia pomiarowego) bezbłędnie i przy wyjątkowo dobrej widoczności pomaga operatorowi w wyborze poziomu w aluminiowej feldze.



13 AUTOMATYCZNY POMIAR SZEROKOŚCI KOŁA

Automatyczny czujnik AWD (Auto width Device) do bezdotykowego pomiaru szerokości koła (opcjonalny)



14 PNEUMATYCZNE MOCOWANIE KOŁA

Pneumatyczny system mocowania koła za pomocą pedału.



15 AUTOMATYCZNE POZYCJONOWANIE

Automatyczne zatrzymanie koła następuje w punkcie, gdzie wyważony ciężar jest pozycjonowany (RPA) oraz stosowany jest elektryczny hamulec

SPIS TREŚCI

Kliknij na produkt, lub stronę, aby się na nią przenieść.

WYWAŻARKI DO SAMOCHODÓW OSOBOWYCH/VAN/BUS

EYE-LIGHT PLUS DIAGNOSTICLINE	6
EM 9980C PLUS DIAGNOSTICLINE	7
EM 9780C PLUS AUTOMATICLINE	8
EM 9680 C PLUS DOTLINE TOUCH	9
EM 9680 PLUS DOTLINE TOUCH	10
EM 9550 C PLUS LASERLINE	11
EM 9550 PLUS LASERLINE	12
EM 9380 C XLINE TOUCHSCREEN	13
EM 9380 C XLINE	13
EM 9380 XLINE TOUCHSCREEN	14
EM 9380 XLINE	14
EM 9350 C XLINE	15
EM 9350 XLINE	16
EM 9280 C COMPACTLINE	17
EM 9280 COMPACTLINE	18
EM 9250 COMPACTLINE	18

WYWAŻARKI DO MOBILNYCH SERWISÓW SAMOCHODOWYCH

EM 9050 SPACESAVER	48
EM 9050 - TILT-UP - HAND SPIN	49
EM 9050 - SLIDE - MOTORIZED SPIN	50
EM 9050 - WORKBENCH - HAND SPIN	51
EM 9050 - WORKBENCH - MOTORIZED SPIN	51

REKOMENDOWANE AKCESORIA DLA MOBILNYCH SERWISÓW SAMOCHODOWYCH

[52](#)

WYWAŻARKI DO MOTOCYKLI

EM 9250 BASIC BIKELINE	19
--	--------------------

AKCESORIA DLA WYWAŻAREK SAMOCHODOWYCH I DO MOTOCYKLI	21
--	--------------------

WYWAŻARKI DO SAMOCHODÓW OSOBOWYCH/VAN/BUS

EYE-LIGHT PLUS DIAGNOSTICLINE

WINUT



STANDARDOWE AKCESORIA

Kod 8-21100221



Kod
802227308



Kod
8-21100142



Kod 5-120500A

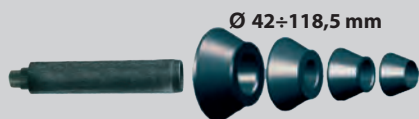

x3



dla wersji Winut



32"

Wersja Winut



Kod	Zasilanie	Opis	Cena netto
0-21101100/16	100-230V / 1P _H / 50-60Hz	<p>Eye-Light Plus DiagnosticLine Diagnostyczna wyważarka z dotykowym monitorem LCD, przemysłowym komputerem klasy PC, kamerą, systemem WM, automatyczną osłoną koła, bezkontaktowym systemem pobierania danych za pomocą lasera, systemem iPos - system optymalizacji do najlepszego pozycjonowania kół na pojeździe oraz automatycznym mocowaniem koła, panel na tulejki HPC, zestaw tulejek HPC.</p> <p>Diagnostyka koła, lub obręczy przy pomocy precyzyjnych promieni laserowych:</p> <ul style="list-style-type: none"> a) precyzyjny pomiar bicia koła we wszystkich płaszczyznach (bicie promieniowe i boczne) oraz kalkulacja optymalnego spasowania felga-opona, rozwiązujący większość problemów wibracji powodowanych ogumieniem, b) ścięcie opony, stan który powoduje że pojazd jest stale ciągnięty w jedną stronę w czasie jazdy w linii prostej, c) głębokość bieżnika w 3 miejscach 	74 031,00
0-21101101/16	100-230V / 1P _H / 50-60Hz	<p>Eye-Light Plus DiagnosticLine WiNUT jak wyżej, z automatycznym bezprzewodowym mocowaniem koła za pomocą tulei z przyciskiem (WINUT), wersja ta nie posiada pedału nożnego.</p>	76 369,00



www.corghi.pl

ODLICZ OD CENY NETTO -25 % RABATU

Cennik SAMiNWEST ważny od 10.07.2026 do ukazania się nowej wersji.

WYWAŻARKI DO SAMOCHODÓW OSOBOWYCH/VAN/BUS

EM 9980C PLUS DiagnosticLine



Kod
8-21100221



Kod
5-120500A

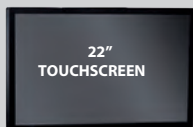

STANDARDOWE AKCESORIA



Kod
8-21100142



dla wersji Winut



Kod
802227308



32"



Wersja Winut



Kod	Zasilanie	Opis	Cena netto
0-21109983/16	100-230V / 1P _H / 50-60Hz	EM 9980C PLUS DiagnosticLine Diagnostyczna wyważarka z dotykowym monitorem LCD, systemem WM, bezkontaktowym systemem pobierania danych za pomocą lasera, systemem iPos- system optymalizacji do najlepszego pozycjonowania kół na pojeździe oraz automatycznym mocowaniem koła. Diagnostyka koła, lub obręczy przy pomocy precyzyjnych promieni laserowych: precyzyjny pomiar bicia koła we wszystkich płaszczyznach (bicie promieniowe i boczne) oraz kalkulacja optymalnego spasowania felga-opona, rozwiązujący większość problemów wibracji powodowanych ogumieniem.	57 615,00
0-21109984/16	100-230V / 1P _H / 50-60Hz	EM 9980C PLUS DiagnosticLine WiNUT J ak wyżej, z automatycznym bezprzewodowym mocowaniem koła za pomocą tulei z przyciskiem (WINUT), wersja ta nie posiada pedału nożnego.	59 954,00



www.corgi.pl

ODLICZ OD CENY NETTO -25 % RABATU

Cennik SAMiNWEST ważny od 10.07.2026 do ukazania się nowej wersji.

WYWAŻARKI DO SAMOCHODÓW OSOBOWYCH/VAN/BUS

EM 9780C PLUS AUTOMATICLINE



STANDARDOWE AKCESORIA

Kod
8-21100221



x3



dla wersji Winut



Kod
802227308

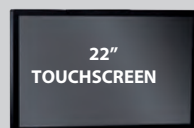

Kod
5-120500A

Kod
8-21100142



32"



Kod	Zasilanie	Opis	Cena netto
0-21109783/16	100-230V / 1P _H / 50-60Hz	EM 9780C PLUS AutomaticLine Wyważarka z dotykowym monitorem LCD, bezkontaktowym systemem wprowadzania danych koła (połączenie lasera i sonaru AWD (standard)), systemem oszczędzania ciężarków (WM), systemem iPos - system optymalizacji do najlepszego pozycjonowania kół na pojeździe oraz automatycznym mocowaniem koła.	46 808,00
0-21109784/16	100-230V / 1P _H / 50-60Hz	EM 9780C PLUS AutomaticLine Winut Jak wyżej, z automatycznym bezprzewodowym mocowaniem koła za pomocą tulei z przyciskiem (WINUT), wersja ta nie posiada pedału nożnego.	49 147,00
8-21100250	-	Sonar diagnostyczny (opcja) precyzyjny pomiar bicia koła we wszystkich płaszczyznach (bicie promieniowe i boczne) oraz kalkulacja optymalnego spasowania felgaopona, rozwiązujący większość problemów wibracji powodowanych ogumieniem	+ 2 714,00

Polecane



www.corghi.pl

ODLICZ OD CENY NETTO -25 % RABATU

Cennik SAMiNWEST ważny od 10.07.2026 do ukazania się nowej wersji.

WYWAŻARKI DO SAMOCHODÓW OSOBOWYCH/VAN/BUS

EM 9680 C DOTLINE TOUCHSCREEN



STANDARDOWE AKCESORIA

Kod
8-11100221



Kod
802227308



Ø 42÷118,5 mm

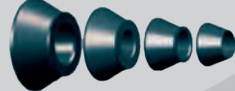

x3



Kod 5-120500A

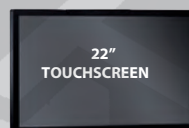

Kod
8-21100142



TOUCHSCREEN



28"



Kod	Zasilanie	Opis	Cena netto
0-21109681/16	100-230V / 1P _H / 50-60Hz	EM 9680 C DOTLINE TOUCHSCREEN Szybka i automatyczna wyważarka do kół, wyposażona w 22-calowy dotykowy ekran, automatyczny zacisk koła (Pneulock), wskaźnik LaserDot, oświetlenie LED, tradycyjne ramię do wprowadzania danych z 28-calowym urządzeniem SmartArm do automatycznego wprowadzania danych z programem szybkiego wyboru FST, osłona koła „Zero Space”, program oszczędzania ciężarków WM PLUS w zestawie. Zalecamy dokupić opcjonalnie AWD (+ 2 773,00 zł).	36 819,00
0-21109680/16	100-230V / 1P _H / 50-60Hz	EM 9680 C DOTLINE TOUCHSCREEN WINUT J ak wyżej, z automatycznym bezprzewodowym mocowaniem koła za pomocą tulei z przyciskiem (WINUT), wersja ta nie posiada pedału nożnego. Zalecamy dokupić opcjonalnie AWD (+ 2 773, 00 zł).	38 157,00
8-21100250	-	Sonar diagnostyczny (opcja) umożliwiający precyzyjny pomiar bicia promieniowego koła w jednej płaszczyźnie.	+ 2 714,00

Polecane



www.corghi.pl

ODLICZ OD CENY NETTO -25 % RABATU

Cennik SAMiNWEST ważny od 10.07.2026 do ukazania się nowej wersji.

WYWAŻARKI DO SAMOCHODÓW OSOBOWYCH/VAN/BUS

EM 9680 PLUS DOTLINE TOUCH



Kod
8-21100221



Kod
802227308



Kod
8-21100142



TOUCHSCREEN



28"

ręczne mocowanie koła
za pomocą nakrętki
szybko-mocującej



Kod	Zasilanie	Opis	Cena netto
0-21109682/16	100-230V / 1P _H / 50-60Hz	EM 9680 DOTLINE TOUCHSCREEN Szybka i automatyczna wyważarka do kół, wyposażona w 22-calowy dotykowy ekran, ręczny zacisk koła, wskaźnik LaserDot, oświetlenie LED, tradycyjne ramię do wprowadzania danych z 28-calowym urządzeniem SmartArm do automatycznego wprowadzania danych z programem szybkiego wyboru FST, osłona koła „Zero Space”, program oszczędzania ciężarków WM PLUS w zestawie. Zalecamy dokupić opcjonalnie AWD (+ 2 773,00 zł).	30 434,00
8-21100250	-	Sonar diagnostyczny (opcja) umożliwiający precyzyjny pomiar bicia promieniowego koła w jednej płaszczyźnie	+ 2 714,00



www.corghi.pl

10

ODLICZ OD CENY NETTO -25 % RABATU

Cennik SAMinWEST ważny od 10.07.2026 do ukazania się nowej wersji.

Zdjęcie ma charakter poglądowy i może przedstawiać urządzenie z akcesoriami opcjonalnymi.

2028323520

EM 9550 C Plus LASERLINE



Kod
8-21100221



Kod
802227308



Kod
8-21100159



STANDARDOWE AKCESORIA



Kod	Zasilanie	Opis	Cena netto
0-21109556/16	100-230V / 1P _H / 50-60Hz	EM 9550 C Plus LaserLine Wyważarka z elektromechanicznym uchwytem szybkoocującym za pomocą pedału, wyświetlaczem, wskaźnikiem laserowym oraz automatycznym dobieraniem odpowiedniego programu wyważania, osłona "Zero space". Zalecamy dokupić opcjonalnie AWD (+ 2 773, 00 zł).	28 643,00

WYWAŻARKI DO SAMOCHODÓW OSOBOWYCH/VAN/BUS

EM 9550 PLUS LASERLINE



Kod
8-21100221



Kod
802227308

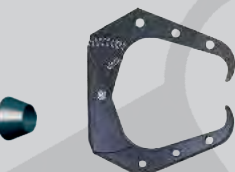

x3

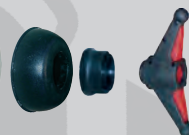

Kod
8-21100159



28"



Kod	Zasilanie	Opis	Cena netto
0-21109557/16	100-230V / 1P _H / 50-60Hz	EM 9550 Plus LaserLine Wyważarka z wyświetlaczem, wskaźnikiem laserowym, automatycznym dobieraniem odpowiedniego programu wyważania, osłona "Zero space". Zalecamy dokupić opcjonalnie AWD (+ 2 773, 00 zł).	23 308,00



www.corgi.pl

WYWAŻARKI DO SAMOCHODÓW OSOBOWYCH/VAN/BUS

EM 9380 C XLINE TOUCHSCREEN

EM 9380 C XLINE



STANDARDOWE AKCESORIA

Kod
8-21100221



Kod
802227308



28"



Kod	Zasilanie	Opis	Cena netto
0-21193806/16	200-230V / 1P _H / 50-60Hz	EM9380C XLine TOUCHSCREEN Wyważarka z dotykowym ekranem, z elektromechanicznym uchwytem szybkoocującym za pomocą pedału, wskaźnikiem laserowym, automatycznym wprowadzaniem danych oraz systemem oszczędzania ciężarków (program WM). Zalecamy dokupić opcjonalnie AWD (+ 2 773,00 zł) i KLIP (+ 243, 00 zł).	33 325,00
0-21193802/16	200-230V / 1P _H / 50-60Hz	EM9380C XLine Wyważarka z monitorem LCD, z elektromechanicznym uchwytem szybkoocującym za pomocą pedału, wskaźnikiem laserowym, automatycznym wprowadzaniem danych oraz systemem oszczędzania ciężarków (program WM). Zalecamy dokupić opcjonalnie AWD (+ 2 773,00 zł) i KLIP (+ 243, 00 zł).	29 554,00



www.corghi.pl

WYWAŻARKI DO SAMOCHODÓW OSOBOWYCH/VAN/BUS

EM 9380 XLINE TOUCHSCREEN EM 9380 XLINE



Kod
8-21100221



Kod
802227308

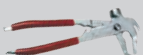

STANDARDOWE AKCESORIA



28"



Kod	Zasilanie	Opis	Cena netto
0-21193805/16	200-230V / 1Ph / 50-60Hz	EM9380 XLine TOUCHSCREEN Wyważarka z monitorem LCD, automatycznym wprowadzaniem danych, wskaźnikiem laserowym oraz systemem oszczędzania ciężarków (program WM). Zalecamy dokupić opcjonalnie AWD (+ 2 773,00 zł) i KLIP (+ 243, 00 zł) .	27 949,00
0-21193800/16	200-230V / 1Ph / 50-60Hz	EM9380 XLine Wyważarka z monitorem LCD, automatycznym wprowadzaniem danych, wskaźnikiem laserowym oraz systemem oszczędzania ciężarków (program WM). Zalecamy dokupić opcjonalnie AWD (+ 2 773,00 zł) i KLIP (+ 243, 00 zł) .	24 174,00



www.corgi.pl

WYWAŻARKI DO SAMOCHODÓW OSOBOWYCH/VAN/BUS

EM 9350 C XLINE



Kod
8-21100221



Kod
802227308

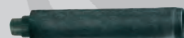
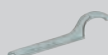

STANDARDOWE AKCESORIA



Kod	Zasilanie	Opis	Cena netto
0-21193502/16	200-230V / 1P _H / 50-60Hz	EM9350C XLine Wyważarka z wyświetlaczem, wskaźnikiem laserowym, z elektromechanicznym uchwytem szybkoocującym za pomocą pedału, automatycznym wprowadzaniem danych. Zalecamy dokupić opcjonalnie AWD (+ 2 773,00 zł) i KLIP (+ 243, 00 zł) .	24 263,00



www.corghi.pl

WYWAŻARKI DO SAMOCHODÓW OSOBOWYCH/VAN/BUS

EM 9350 XLINE



STANDARDOWE AKCESORIA

Kod
8-21100221



Ø 42÷118,5 mm

Kod
802227308



x3

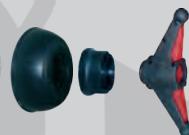

28''



Kod	Zasilanie	Opis	Cena netto
0-21193500/16	200-230V / 1Ph / 50-60Hz	EM9350 XLine Wyważarka z wyświetlaczem, wskaźnikiem laserowym, automatycznym wprowadzaniem danych. Zalecamy dokupić opcjonalnie AWD (+ 2 773,00 zł) i KLIP (+ 243, 00 zł) .	18 787,00



www.corghi.pl

EM 9280 C COMPACTLINE



STANDARDOWE AKCESORIA

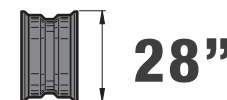
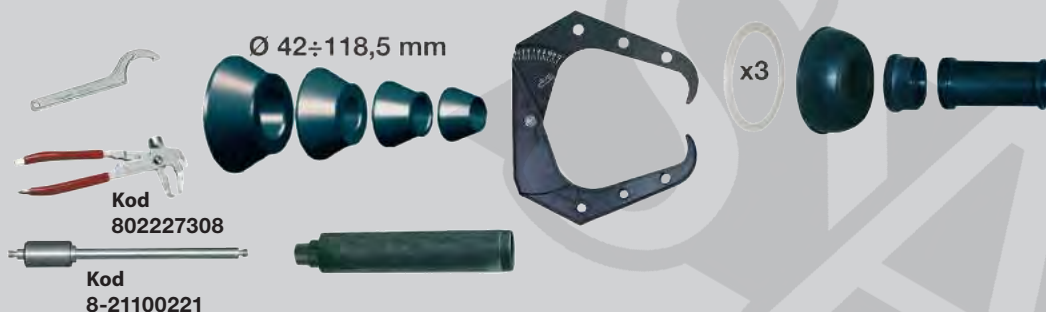

Kod	Zasilanie	Opis	Cena netto
0-21192804/16	200-230V / 1P _H / 50-60Hz	EM9280C CompactLine Wyważarka z monitorem LCD, pneumatycznym uchwytem szybkoocującym, automatycznym wprowadzeniem danych, z automatycznym zatrzymaniem na koniec wyrzutu, z systemem RPA, z systemem oszczędzania ciężarków (Program WM). Zalecamy dokupić opcjonalnie AWD (+ 2 773,00 zł), LASER (+ 1 485,00), KLIP (+ 243, 00) oraz PL50 (+ 384,00).	26 138,00

Polecane

EM 9280 COMPACTLINE



Kod
8-21100221

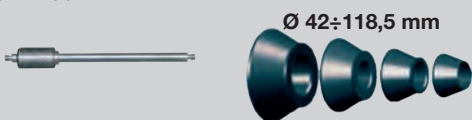

Kod
802227308



STANDARDOWE AKCESORIA



Kod	Zasilanie	Opis	Cena netto
0-21192800/16	200-230V / 1Ph / 50-60Hz	EM9280 CompactLine Wyważarka z monitorem LCD, automatycznym wprowadzeniem danych, z automatycznym zatrzymaniem na koniec wyrzutu, z systemem RPA, z systemem oszczędzania ciężarków (Program WM). Zalecamy dokupić opcjonalnie AWD (+ 2 773,00 zł), LASER (+ 1 485,00), KLIP (+ 243,00) oraz PL50 (+ 384,00).	20 977,00

WYWAŻARKI DO SAMOCHODÓW OSOBOWYCH/VAN/BUS

EM 9250 COMPACTLINE



STANDARDOWE AKCESORIA

Kod
8-21100221



Ø 42÷118,5 mm



x3

Kod
802227308

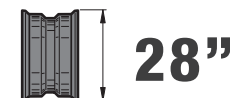

28"



Wersja premium

Kod	Zasilanie	Opis	Cena netto
0-21192508/16	200-230V / 1P _H / 50-60Hz	EM 9250 CompactLine Wersja PREMIUM: Wyświetlacz, automatyczne wprowadzenie danych oraz automatyczne zatrzymanie na koniec wyrzutu. Elektryczny hamulec oraz system RPA. Zalecamy dokupić opcjonalnie AWD (+ 2 773,00 zł), LASER (+ 1 485,00), KLIP (+ 243,00) oraz PL50 (+ 384,00).	14 904,00
0-21192504/16	200-230V / 1P _H / 50-60Hz	EM 9250 CompactLine Wersja PROFESSIONAL: maszyna z wyświetlaczem LCD z automatycznym wprowadzaniem danych i automatycznym hamulcem na końcu wirowania. Zalecamy dokupić opcjonalnie LASER (+ 1 485, 00), KLIP (+ 243,00) oraz PL50 (+ 384, 00).	13 982,00
0-21192500/16	200-230V / 1P _H / 50-60Hz	EM 9250 CompactLine Wersja BASIC: maszyna z wyświetlaczem LCD z ręcznym wprowadzaniem danych i automatycznym hamulcem na końcu wirowania. Zalecamy dokupić opcjonalnie LASER (+ 1 485, 00), KLIP (+ 243,00) oraz PL50 (+ 384, 00).	12 136,00



www.corghi.pl

WYWAŻARKI DO MOTOCYKLI

EM 9250 BASIC BIKELINE



28"

Kod	Zasilanie	Opis	Cena netto
0-21192512/16	200-230V / 1Ph / 50-60Hz	EM 9250 Wyważarka do kół motocyklowych z ręcznym wprowadzeniem danych i ręcznym mocowaniem kół, zawiera wyświetlacz LCD. W zestawie z BIKE UNIVERSAL KIT i PRA4.	15 580,00





www.corghi.pl

ODLICZ OD CENY NETTO -25 % RABATU



Cennik SAMiNWEST ważny od 10.07.2026 do ukazania się nowej wersji.

AKCESORIA DO WYWAŻAREK SAMOCHODOWYCH I MOTOCYKLOWYCH

	Opis	Kod	Cena netto	EYE-LIGHT PLUS	EM9980 C PLUS	EM9780 C PLUS	EM9680 C PLUS DOTLINE	EM9680 PLUS DOTLINE	EM9580 C PLUS TOUCH	EM9580 C PLUS	EM9550 C Plus	EM9550 Plus	EM9380 C / TOUCHSCREEN	EM9380 / TOUCHSCREEN	EM9350 C	EM9350	EM9280 C	EM9280	EM9250 C PREMIUM	EM9250 PREMIUM	EM9250 PROFESSIONAL	EM9250 BASIC	EM9250 BASIC BIKE LINE	
MONITORY																								
	Monitor 22"	8-21100234	1 480,00	-	-	-	-	-	O	O	-	-	O	O	-	-	-	-	-	-	-	-	-	-
	Zestaw do czyszczenia monitorów	8-21120006	124,00	O	O	O	O	O	O	O	-	-	O	O	-	-	O	O	-	-	-	-	-	-



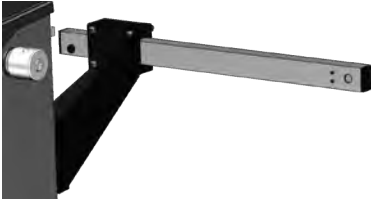

■ = Standard O = Kompatybilne - = NIEkompatybilne

AKCESORIA DO WYWAŻAREK SAMOCHODOWYCH I MOTOCYKLOWYCH

Opis	Kod	Cena netto	EYE-LIGHT PLUS	EM9880 C PLUS	EM9780 C PLUS	EM9680 C PLUS DOTLINE	EM9680 PLUS DOTLINE	EM9580 C PLUS TOUCH	EM9580 C PLUS	EM9550 C Plus	EM9550 Plus	EM9380 C / TOUCHSCREEN	EM9380 / TOUCHSCREEN	EM9350 C	EM9350	EM9280 C	EM9280	EM9250 C PREMIUM	EM9250 PREMIUM	EM9250 PROFESSIONAL	EM9250 BASIC	EM9250 BASIC BikeLine	
			URZĄDZENIA ELEKTRONICZNE																				
 LAN CONNECTION KIT	ZESTAW DO PODŁĄCZENIA SIECI LAN Zestaw do podłączenia wyważarki do sieci systemu zarządzania firmą; pozwala przeglądać, archiwizować i drukować zdalnie różne raporty pomiarowe i diagnostyczne wyważarki diagnostycznej.	8-21100255	1 220,00	O	O	O	O	C	O	O	-	-	O	O	-	-	O	O	-	-	-	-	-
	Zestaw RRS-2, zestaw sonaru	8-21100277	2 092,00	-	-	-	-	-	-	-	-	-	O	O	-	-	O	O	-	-	-	-	-
	EG1 Pomiar szerokości koła.	8-21100074	2 563,00	-	-	-	-	-	-	-	-	-	-	-	-	-	-	-	-	-	O	-	-
	WYKRYWANIE ROZMIARÓW KOŁA cyfrowy miernik do pozyskiwania średnicy i odległości. Maksymalna precyzja przy wykorzystaniu systemu FSP, który automatycznie dobiera odpowiedni program wyważania.	8-21120022	1 033,00	-	-	-	-	-	-	-	-	O	O	O	O	O	O	O	O	O	O	O	O

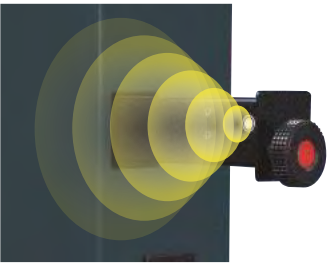

■ = Standard O = Kompatybilne - = NIEkompatybilne

AKCESORIA DO WYWAŻAREK SAMOCHODOWYCH I MOTOCYKLOWYCH

	Opis	Kod	Cena netto	EYE-LIGHT PLUS	EM9980 C PLUS	EM9780 C PLUS	EM9680 C PLUS DOTLINE	EM9680 PLUS DOTLINE	EM9580 C PLUS TOUCH	EM9580 C PLUS	EM9550 C Plus	EM9550 Plus	EM9380 C / TOUCHSCREEN	EM9380 / TOUCHSCREEN	EM9350 C	EM9350	EM9280 C	EM9280	EM9250 C PREMIUM	EM9250 PREMIUM	EM9250 PROFESSIONAL	EM9250 BASIC	EM9250 BASIC BIKELINE	
	WYKRYWANIE ROZMIARÓW KOŁA cyfrowy miernik do pozyskiwania średnicy i odległości. Maksymalna precyzja przy wykorzystaniu systemu FSP, który automatycznie dobiera odpowiedni program wyważania.	8-21120023	1 033,00	-	-	-	-	-	■	■	■	■	-	-	-	-	-	-	-	-	-	-	-	-
	Laser & Led Zestaw wskaźnika laserowego i światło LED	8-21100238	1 485,00	-	-	-	-	-	-	-	-	-	-	-	-	-	○	○	○	○	○	○	○	-
	AWD Zestaw do ultradźwiękowego pomiaru szerokości koła Sonar Sensor.	8-21100293	2 773,00	-	-	■	○	○	○	○	○	○	○	○	○	○	○	○	○	○	○	-	-	-
	ZESTAW DO MONTAŻU - WINUT do dodania systemu WiNut do wyważarek wyprodukowanych bez niego; EM92xx-C i EM93xx-C produkowane od lipca 2019 r	8-21100242	3 152,00	○	○	○	○	-	○	-	-	-	○	-	○	-	○	-	○	-	-	-	-	
	Zestaw Sonar RUNOUT z nowymi funkcjami BESTFIT	8-21100250	2 714,00	-	-	○	○	○	○	○	-	-	-	-	-	-	-	-	-	-	-	-	-	





■ = Standard ○ = Kompatybilne - = NIEkompatybilne

AKCESORIA DO WYWAŻAREK SAMOCHODOWYCH I MOTOCYKLOWYCH

	Opis	Kod	Cena netto	EYE-LIGHT PLUS	EM9980 C PLUS	EM9780 C PLUS	EM9680 C PLUS DOTLINE	EM9680 PLUS DOTLINE	EM9580 C PLUS TOUCH	EM9580 C PLUS	EM9550 C Plus	EM9550 Plus	EM9380 C / TOUCHSCREEN	EM9380 / TOUCHSCREEN	EM9350 C	EM9350	EM9280 C	EM9280	EM9250 C PREMIUM	EM9250 PREMIUM	EM9250 PROFESSIONAL	EM9250 BASIC	EM9250 BASIC BIKE LINE
PODNOŚNIKI																							
	TT-0 Automatyczny samopoziomujący podnośnik koła. Zasilanie pneumatyczne. Udźwig 80kg.	8-21100230	10 108,00	0	0	0	0	0	0	0	0	0	0	0	0	0	0	0	0	0	0	0	0
	TT-R Profesjonalny regulowany podnośnik nożycowy, sterowanie jedną ręką, udźwig 80 kg	8-21100248	7 021,00	0	0	0	0	0	0	0	0	0	0	0	0	0	0	0	0	0	0	0	0
	Zestaw montażowy do podnośnika TT-ZERO GRAVITY i TT-R , tylko do EM9380, EM9350, EM9280 i 9250.	8-21100231	215,00	-	-	-	-	-	-	-	-	0	0	0	0	0	0	0	0	0	0	0	0

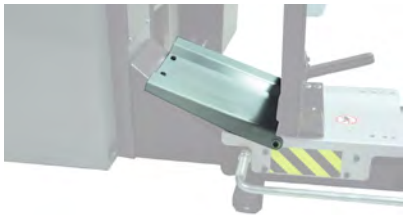

■ = Standard O = Kompatybilne - = NIEkompatybilne

AKCESORIA DO WYWAŻAREK SAMOCHODOWYCH I MOTOCYKLOWYCH

	Opis	Kod	Cena netto	EYE-LIGHT PLUS	EM9980 C PLUS	EM9780 C PLUS	EM9680 C PLUS DOTLINE	EM9680 PLUS DOTLINE	EM9580 C PLUS TOUCH	EM9580 C PLUS	EM9550 C Plus	EM9550 Plus	EM9380 C / TOUCHSCREEN	EM9380 / TOUCHSCREEN	EM9350 C	EM9350	EM9280 C	EM9280	EM9250 C PREMIUM	EM9250 PREMIUM	EM9250 PROFESSIONAL	EM9250 BASIC	EM9250 Basic BikeLine	
	Zestaw klap do podnośnika TT-ZERO GRAVITY i TT-R (umożliwia montaż podnośnika na wyważarce ze stopką boczną) do EM9280, EM9250.	8-21600132	594,00	-	-	-	-	-	-	-	-	-	-	-	-	-	0	0	0	0	0	0	0	0
	TT 80 PLUS Uniwersalny podnośnik pneumatyczny, maks. obciążenie kg 80.	8-21100161/90	4 011,00	0	0	0	0	0	0	0	0	0	0	0	0	0	0	0	0	0	0	0	0	0
	FTT1 Zestaw montażowy do TT80.	8-21100163	215,00	-	-	-	-	-	-	-	-	-	0	0	0	0	0	0	0	0	0	0	0	0
	FTT2 Zestaw montażowy do TT80.	8-21120002	215,00	0	0	0	0	0	0	0	0	0	-	-	-	-	-	-	-	-	-	-	-	-

■ = Standard 0 = Kompatybilne - = NIEkompatybilne

AKCESORIA DO WYWAŻAREK SAMOCHODOWYCH I MOTOCYKLOWYCH

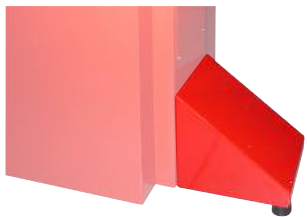

	Opis	Kod	Cena netto	EYE-LIGHT PLUS	EM9980 C PLUS	EM9780 C PLUS	EM9680 C PLUS DOTLINE	EM9680 PLUS DOTLINE	EM9580 C PLUS TOUCH	EM9580 C PLUS	EM9550 C Plus	EM9550 Plus	EM9380 C / TOUCHSCREEN	EM9380 / TOUCHSCREEN	EM9350 C	EM9350	EM9280 C	EM9280	EM9250 C PREMIUM	EM9250 PREMIUM	EM9250 PROFESSIONAL	EM9250 BASIC	EM9250 BASIC BIKE LINE	
ZESTAWY MODERNIZACYJNE																								
	Boczny panel podtrzymujący : panel podtrzymujący uchwyt na akcesoria do zestawów centrujących i zestawów HPC, malowany na kolor czerwony (dla wyważarek pomalowanych już na kolor czerwony RAL 3002 - /16)	8-21100258/16	494,00	-	-	-	-	-	-	-	-	-	-	-	-	-	0	0	0	0	0	0	0	0
	Boczny panel podtrzymujący : panel podtrzymujący uchwyt na akcesoria do zestawów centrujących i zestawów HPC, malowany na kolor czerwony (dla wyważarek niepomalowanych na kolor czerwony RAL 3002 - /16)	8-21100258/90	494,00	-	-	-	-	-	-	-	-	-	-	-	-	-	0	0	0	0	0	0	0	0
	Panel nośny do zestawu centrującego HPC High Precision Collets, lakierowany na kolor czerwony (do wyważarek lakierowanych już na kolor czerwony RAL 3002 w /16)	8-21100253/16	987,00	-	0	0	0	0	0	0	0	0	-	-	-	-	-	-	-	-	-	-	-	-
	Panel nośny do zestawu centrującego HPC High Precision Collets, lakierowany na kolor czerwony (do wyważarek niepomalowanych na kolor czerwony RAL 3002 w /16)	8-21100253/90	987,00	■	0	0	0	0	0	0	0	0	-	-	-	-	-	-	-	-	-	-	-	-
	PL50 Stopka do montażu bez kotwienia do podłoża. Maksymalny ciężar koła jest ograniczony do 50 kg z zamontowaną stopą (CZERWONA)	8-21100158/16	384,00	-	-	-	-	-	-	-	-	-	-	-	-	-	0	0	0	0	0	0	0	0
	PL50 Stopka do montażu bez kotwienia do podłoża. Maksymalny ciężar koła jest ograniczony do 50 kg z zamontowaną stopą (CZARNA)	8-21100158/90	384,00	-	-	-	-	-	-	-	-	-	-	-	-	-	0	0	0	0	0	0	0	0

■ = Standard 0 = Kompatybilne - = NIEkompatybilne







www.corgi.pl

AKCESORIA DO WYWAŻAREK SAMOCHODOWYCH I MOTOCYKLOWYCH

	Opis	Kod	Cena netto	EYE-LIGHT PLUS	EM9980 C PLUS	EM9780 C PLUS	EM9680 C PLUS DOTLINE	EM9680 PLUS DOTLINE	EM9580 C PLUS TOUCH	EM9580 C PLUS	EM9550 C Plus	EM9550 Plus	EM9380 C / TOUCHSCREEN	EM9380 / TOUCHSCREEN	EM9350 C	EM9350	EM9280 C	EM9280	EM9250 C PREMIUM	EM9250 PREMIUM	EM9250 PROFESSIONAL	EM9250 BASIC	EM9250 Basic BikeLine	
	Zestaw kolorów do personalizacji tylko dla EM9250 i EM9280	8-21100245/xx	398,00	-	-	-	-	-	-	-	-	-	-	-	-	-	0	0	0	0	0	0	0	0
	Zestaw ASF - Regulowana stopka stabilizująca, optymalizuje stabilność wyważarki kół w przypadku przypadkowego kontaktu operatora	8-21100299	92,00	0	0	0	0	0	0	0	0	0	0	0	0	0	0	0	0	0	0	0	0	0





■ = Standard O = Kompatybilne - = NIEkompatybilne

AKCESORIA DO WYWAŻAREK SAMOCHODOWYCH I MOTOCYKLOWYCH

Opis	Kod	Cena netto	EYE-LIGHT PLUS	EM9980 C PLUS	EM9780 C PLUS	EM9680 C PLUS DOTLINE	EM9680 PLUS DOTLINE	EM9580 C PLUS TOUCH	EM9580 C PLUS	EM9550 C Plus	EM9550 Plus	EM9380 C / TOUCHSCREEN	EM9380 / TOUCHSCREEN	EM9350 C	EM9350	EM9280 C	EM9280	EM9250 C PREMIUM	EM9250 PREMIUM	EM9250 PROFESSIONAL	EM9250 BASIC	EM9250 BASIC BIKE LINE	
RÓŻNE																							
	ZESTAW DOZOWNIKA : łatwy w użyciu zestaw dozujący do odważników.	8-21100251	430,00	O	O	O	O	O	O	O	O	O	O	O	O	O	O	O	O	O	O	O	O
	Samoprzylepna rolka odważników: metalowa szpula 5 gr x 1200 - 6 kg	8-21100252	229,00	O	O	O	O	O	O	O	O	O	O	O	O	O	O	O	O	O	O	O	O
	Kompletny zestaw osłon kół do serii EM92xx	8-21100246/90	1 485,00	-	-	-	-	-	-	-	-	-	-	-	-	O	O	O	O	O	O	O	O
	Hamulec zaciskowy pedału CB tylko dla EM9250.	8-21100191	695,00	-	-	-	-	-	-	-	-	-	-	-	-	-	-	-	-	O	O	O	O
	AWR urządzenie do usuwania ciężarków.	802461006	106,00	O	O	O	O	O	O	O	O	O	O	O	O	O	O	O	O	O	O	O	O

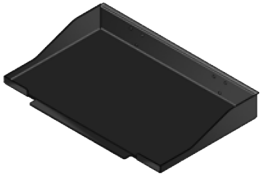

■ = Standard O = Kompatybilne - = NIEkompatybilne

AKCESORIA DO WYWAŻAREK SAMOCHODOWYCH I MOTOCYKLOWYCH

	Opis	Kod	Cena netto	EYE-LIGHT PLUS	EM9980 C PLUS	EM9780 C PLUS	EM9680 C PLUS DOTLINE	EM9680 PLUS DOTLINE	EM9580 C PLUS TOUCH	EM9580 C PLUS	EM9550 C Plus	EM9550 Plus	EM9380 C / TOUCHSCREEN	EM9380 / TOUCHSCREEN	EM9350 C	EM9350	EM9280 C	EM9280	EM9250 C PREMIUM	EM9250 PREMIUM	EM9250 PROFESSIONAL	EM9250 BASIC	EM9250 BASIC BIKELINE
	PR Inkjet drukarka USB.	8-21120005	750,00	O	O	O	O	O	O	O	-	-	-	-	-	-	-	-	-	-	-	-	-
	PRS podstawka na drukarkę.	8-21100236/90	471,00	O	O	O	O	O	O	O	-	-	-	-	-	-	-	-	-	-	-	-	-
	PFC szczypce do ciężarków.	802227308	261,00	■	■	■	■	■	■	■	■	■	■	■	■	■	■	■	■	■	■	■	■
	Klip do wspomagania nakładania ciężarków samoprzylepnych dla EM92XX, EM93XX.	8-21100159	243,00	-	-	-	■	■	■	■	■	■	O	O	O	O	O	O	O	O	O	O	O
	PPT zacisk docisku stopy.	8-21100225	1 617,00	O	O	O	O	O	O	O	O	O	O	O	O	O	O	O	O	O	O	O	O

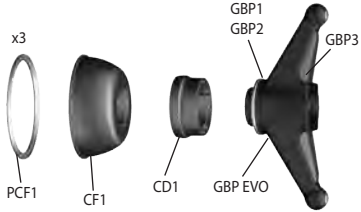

■ = Standard O = Kompatybilne - = NIEkompatybilne

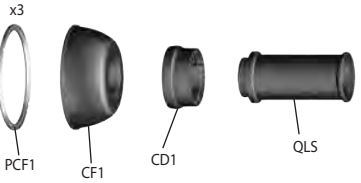
AKCESORIA DO WYWAŻAREK SAMOCHODOWYCH I MOTOCYKLOWYCH

	Opis	Kod	Cena Netto	EYE-LIGHT PLUS	EM9980 C PLUS	EM9780 C PLUS	EM9680 C PLUS DOTLINE	EM9680 PLUS DOTLINE	EM9580 C PLUS TOUCH	EM9580 C PLUS	EM9550 C Plus	EM9550 Plus	EM9380 C / TOUCHSCREEN	EM9380 / TOUCHSCREEN	EM9350 C	EM9350	EM9280 C	EM9280	EM9250 C PREMIUM	EM9250 PREMIUM	EM9250 PROFESSIONAL	EM9250 BASIC	EM9250 BASIC BIKELINE		
ZESTAWY DO CENTROWANIA KÓŁ																									
	GBP40 EVO KIT – profesjonalny zestaw szybkich nakrętek $\varnothing 40 \times 3 \text{mm}$	8-21100289	672,00	-	-	-	-	■	-	■	-	■	-	■	-	■	-	■	-	■	■	■	■	O	
	PCF1 Ochroniac koła do centrowania felg aluminiowych	4-115868																							
	CF1 Nasadka zacisku koła	4-115863																							
	CD1 Nasadka dystansowa	4-115864																							
	GBP EVO Szybka nakrętkat	5-101561																							
	GBP1 Zacisk „R”	4-104798																							
	GBP2 Zacisk „L”	4-104799																							
	GBP3 Lever	4-104796																							
	CCK3 EVO KIT – zestaw stożków centrujących $\varnothing 40 \text{mm}$ $42 \div 103,5 \text{mm}$	8-21100280	804,00	■	■	■	■	■	■	■	■	■	■	■	■	■	■	■	■	■	■	■	■	O	
	CP1 Mały stożek $\varnothing 42 \div 68 \text{ mm}$	5-107970																							
	CP2 Średni stożek $\varnothing 60 \div 87 \text{ mm}$	5-107968																							
	CP3 Duży stożek $\varnothing 83 \div 103 \text{ mm}$	5-107969																							
	MFL – wał gwintowany XL $\varnothing 40 \times 3 \text{mm}$ - długość: 220mm	8-21100193	882,00	-	-	-	-	O	-	O	-	O	-	O	-	O	-	O	-	O	O	O	O	O	
	MBP40 EVO KIT – Zestaw tulei blokujących do elektrycznego lub pneumatycznego systemu blokowania kół	8-21100285	1 014,00	■	■	■	■	-	■	-	■	-	■	-	■	-	■	-	■	-	-	-	-		
	PCF1 Ochroniac koła do centrowania felg aluminiowych	4-115868																							
	CF1 Nasadka zacisku koła	4-115863																							
	CD1 Nasadka dystansowa	4-115864																							
	QLS Szybkozamykający rękaw	5-107394																							

■ = Standard O = Kompatybilne - = NIEkompatybilne

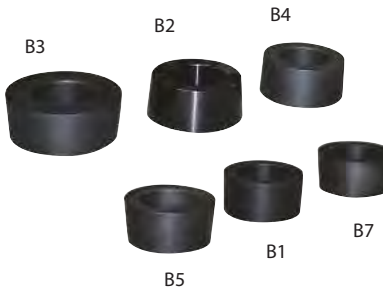



AKCESORIA DO WYWAŻAREK SAMOCHODOWYCH I MOTOCYKLOWYCH

	Opis	Kod	Cena Netto	EYE-LIGHT PLUS	EM9980 C PLUS	EM9780 C PLUS	EM9680 C PLUS DOTLINE	EM9680 PLUS DOTLINE	EM9580 C PLUS TOUCH	EM9580 C PLUS	EM9550 C PLUS	EM9550 Plus	EM9380 C / TOUCHSCREEN	EM9380 / TOUCHSCREEN	EM9350 C	EM9350	EM9280 C	EM9280	EM9250 C PREMIUM	EM9250 PREMIUM	EM9250 PROFESSIONAL	EM9250 BASIC	EM9250 BASIC BIKE LINE	
ZESTAWY DO CENTROWANIA KÓŁ																								
	SBC Zestaw 6 tulei do centrowania odwrotnej strony Ø 40 mm	8-21100082	1 307,00	0	0	0	0	0	0	0	0	0	0	0	0	0	0	0	0	0	0	0	0	
	B1 AUDI, BMW, Chrysler, Opel, Rover, Seat, VW, Daewoo, Galaxy (Ford), Lotus, British-Leyland, Smart (Mercedes), Skoda	4-105075																						
	B2 Citroën, Hyundai, Lancia, Maserati, Mazda, Mercedes, Mitsubishi, Nissan, Opel, Peugeot, Saab, Volvo.	4-105076																						
	B3 BMW, Jaguar, Aston Martin.	4-105077																						
	B4 Ford, Honda, Rover	4-105078																						
	B5 Autobianchi, Alfa Romeo, Citroën, Fiat, Lada, Lancia, Jalbot, Biturbo (Maserati), Mazda, Nissan, Peugeot, Porsche, Renault, 2600-3500 serie (Rover), Seat =>90, Skoda, Toyota.	4-105079																						
	B7 Citroën, Daihatsu, Honda, Kia, Mazda, Mitsubishi, Peugeot, Rover, Subaru, Toyota, Agila (Opel), Suzuki, Hyuday.	4-105080																						
	Zestaw centrujący HPC High Precision Collets (8 dwustronnych, lekko stożkowych tulei)	8-21100244	2 956,00	■	0	0	0	0	0	0	0	0	0	0	0	0	0	0	0	0	0	0	0	
	Wózek do zestawu HPC.	8-21100243/90	1 197,00	0	0	0	0	0	0	0	0	0	0	0	0	0	0	0	0	0	0	0	0	

■ = Standard 0 = Kompatybilne - = NIEkompatybilne

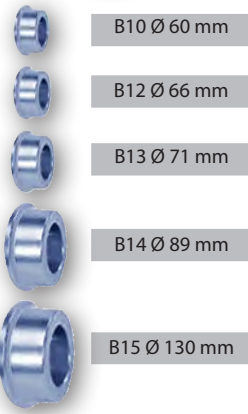

AKCESORIA DO WYWAŻAREK SAMOCHODOWYCH I MOTOCYKLOWYCH



	Opis	Kod	Cena Netto	EYE-LIGHT PLUS	EM9980 C PLUS	EM9780 C PLUS	EM9680 C PLUS DOTLINE	EM9680 PLUS DOTLINE	EM9580 C PLUS TOUCH	EM9580 C PLUS	EM9550 C Plus	EM9550 Plus	EM9380 C / TOUCHSCREEN	EM9380 / TOUCHSCREEN	EM9350 C	EM9350	EM9280 C	EM9280	EM9250 C PREMIUM	EM9250 PREMIUM	EM9250 PROFESSIONAL	EM9250 BASIC	EM9250 BASIC BIKELINE	
ZESTAWY DO CENTROWANIA KÓŁ																								
	Tuleja B6 „Racing” Ø 67 mm do FERRARI / MASERATI	8-21100083	448,00	O	O	O	O	O	O	O	O	O	O	O	O	O	O	O	O	O	O	O	O	O
	Tuleja B9 OPEL Ø 56,5-65-70,1 mm	8-21100085	448,00	O	O	O	O	O	O	O	O	O	O	O	O	O	O	O	O	O	O	O	O	O
	RENAULT Zestaw 5 tulei Renault	8-21100229	1 627,00	O	O	O	O	O	O	O	O	O	O	O	O	O	O	O	O	O	O	O	O	
	B10 60 mm	4-105106																						
	B12 66 mm	4-107025																						
	B13 71 mm	4-107026																						
	B14 89 mm	4-107027																						
	B15 130 mm	4-107028																						
	Zestaw BMW/MINI Ø 66,5 / Ø 56,5 - Ø 72,5 - Ø 74 mm B6 - Ø 66.5 mm - 4-105103 B11 - Ø 56.5 - Ø 72.5 - Ø 74 mm - 4-105108	8-21100228	823,00	O	O	O	O	O	O	O	O	O	O	O	O	O	O	O	O	O	O	O	O	
	Zestaw MERCEDES Ø 57. Ø 65, Ø 66,5, Ø 84 mm	8-21400022	841,00	O	O	O	O	O	O	O	O	O	O	O	O	O	O	O	O	O	O	O	O	
	B16 Ø 57, Ø 66,5, Ø 67 mm	4-138168																						
	B17 Ø 60, Ø 84 mm	4-138169																						

■ = Standard O = Kompatybilne - = NIEkompatybilne

AKCESORIA DO WYWAŻAREK SAMOCHODOWYCH I MOTOCYKLOWYCH



	Opis	Kod	Cena Netto	EYE-LIGHT PLUS	EM9980 C PLUS	EM9780 C PLUS	EM9680 C PLUS DOTLINE	EM9680 PLUS DOTLINE	EM9580 C PLUS TOUCH	EM9580 C PLUS	EM9550 C Plus	EM9550 Plus	EM9380 C / TOUCHSCREEN	EM9380 / TOUCHSCREEN	EM9350 C	EM9350	EM9280 C	EM9280	EM9250 C PREMIUM	EM9250 PREMIUM	EM9250 PROFESSIONAL	EM9250 BASIC	EM9250 BASIC BIKELINE

ZESTAWY DO CENTROWANIA KÓŁ

	Zestaw BMW SPECIAL Ø 81.5 mm (BMW 28 502 923)	8-21100304	375,00	O	O	O	O	O	O	O	O	O	O	O	O	O	O	O	O	O	O	O	O	O
 B21 B22	Zestaw BMW CENTRAL LOCK (BMW 28 502 962)	8-21100305	800,00	O	O	O	O	O	O	O	O	O	O	O	O	O	O	O	O	O	O	O	O	O
	B21 Ø 70 mm	4-150579																						
	B22 BMW PRESSURE	4-129225																						
 B18 B19 B20	Zestaw PORSCHE	8-21101404	937,00	O	O	O	O	O	O	O	O	O	O	O	O	O	O	O	O	O	O	O	O	O
	B18 Ø 71,6/84/66,5 mm	4-150348																						
	B19 PORSCHE 918	4-150350																						
	B20 PORSCHE PRESSURE	4-129095																						



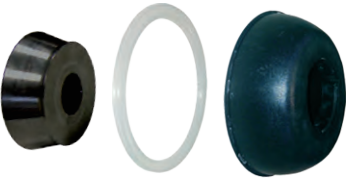
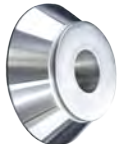

■ = Standard O = Kompatybilne - = NIEkompatybilne

AKCESORIA DO WYWAŻAREK SAMOCHODOWYCH I MOTOCYKLOWYCH

	Opis	Kod	Cena netto	EYE-LIGHT PLUS	EM9980 C PLUS	EM9780 C PLUS	EM9680 C PLUS DOTLINE	EM9680 PLUS DOTLINE	EM9580 C PLUS TOUCH	EM9580 C PLUS	EM9550 C PLUS	EM9550 PLUS	EM9380 C / TOUCHSCREEN	EM9380 / TOUCHSCREEN	EM9350 C	EM9350	EM9280 C	EM9280	EM9250 C PREMIUM	EM9250 PREMIUM	EM9250 PROFESSIONAL	EM9250 BASIC	EM9250 BASIC BIKELINE	
CENTROWANIE KOŁA																								
	CIP Stożek pośredni Ø 55÷72 mm Niezastąpione akcesorium do kół z plastikowymi kołpakami i kół z krótkimi otworami w piasku. Wymiary CIP zapobiegają jego wystawianiu przez otwór piasty z przodu, zapobiegając uszkodzeniu przodu koła, ponieważ w tych kołach przednia średnica otworu piasty jest mniejsza niż średnica tylnego otworu centrującego.	8-21100200	329,00	O	O	O	O	O	O	O	O	O	O	O	O	O	O	O	O	O	O	O	O	O
	ARF Akcesorium do kół terenowych Ø102,5÷118,5mm Ø 101÷119 mm.	8-21100080	530,00	■	■	■	■	■	■	■	■	■	■	■	■	■	■	■	■	■	■	■	■	O
	CGF Stożek do kół terenowych (dostawcze)	5-107971																						
	PCF1 Ochroniacz koła do centrowania felg aluminiowych	4-115868																						
	CF1 Kołpak mocujący koła ø 147 mm	4-115863																						
	Stożek centrujący Ø95 do Ø137 mm.	8-21100096	626,00	O	O	O	O	O	O	O	O	O	O	O	O	O	O	O	O	O	O	O	O	O
	Stożek do lekkich ciężarówek Ø 110÷132 mm.	8-21100201	768,00	O	O	O	O	O	O	O	O	O	O	O	O	O	O	O	O	O	O	O	O	O
	DX2 podkładka dystansowa	341843																						
	CST Stożek do lekkiej ciężarówki ø 110÷132 mm	4-112320																						





■ = Standard O = Kompatybilne - = NIEkompatybilne

AKCESORIA DO WYWAŻAREK SAMOCHODOWYCH I MOTOCYKLOWYCH

Opis	Kod	Cena netto	EYE-LIGHT PLUS	EM9980 C PLUS	EM9780 C PLUS	EM9680 C PLUS DOTLINE	EM9680 PLUS DOTLINE	EM9580 C PLUS TOUCH	EM9580 C PLUS	EM9550 C Plus	EM9550 Plus	EM9380 C / TOUCHSCREEN	EM9380 / TOUCHSCREEN	EM9350 C	EM9350	EM9280 C	EM9280	EM9250 C PREMIUM	EM9250 PREMIUM	EM9250 PROFESSIONAL	EM9250 BASIC	EM9250 BASIC BIKE LINE	
			CENTROWANIE KOŁA																				
 <p>DX1 CF1 CF2</p>	DX/CBF Akcesorium centrujące do kół samochodów dostawczych i terenowych z centralnym otworem o średnicy 117÷173 mm.	8-21100141	1 709,00	O	O	O	O	O	O	O	O	O	O	O	O	O	O	O	O	O	O	O	O
	DX1 Nasadka dystansowa	4-107426																					
	CF1 Stożek do samochodów dostawczych ø 117÷147 mm	4-107423																					
	CF2 Stożek do samochodów dostawczych 143÷173 mm	4-107424																					
 <p>DX1 CF161</p>	DX1/CF161 Professional centring kits for Mercedes Benz Sprinter and Volkswagen Crafter commercial vehicles with central hole with Ø 161 mm.	8-21120004	1 156,00	O	O	O	O	O	O	O	O	O	O	O	O	O	O	O	O	O	O	O	
	DX1 Nasadka dystansowa	4-107426																					
	CF161 Stożek centrujący Ø 161 mm	4-131929																					
NASADKI DYSTANSOWE																							
	DM Nasadka dystansowa Ø 40 mm	8-21100088	357,00	O	O	O	O	O	O	O	O	O	O	O	O	O	O	O	O	O	O	O	
 <p>ARS DARS</p>	ARS Racing akcesorium do kół sportowych, do użytku z tuleją wyścigową	8-21100089	1 243,00	O	O	O	O	O	O	O	O	O	O	O	O	O	O	O	O	O	O	O	

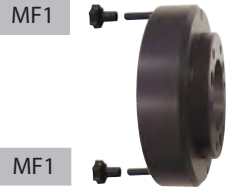

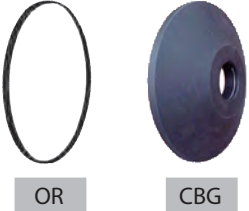

■ = Standard O = Kompatybilne - = NIEkompatybilne

AKCESORIA DO WYWAŻAREK SAMOCHODOWYCH I MOTOCYKLOWYCH

	Opis	Kod	Cena netto	EYE-LIGHT PLUS	EM9980 C PLUS	EM9780 C PLUS	EM9680 C PLUS DOTLINE	EM9680 PLUS DOTLINE	EM9580 C PLUS TOUCH	EM9580 C PLUS	EM9550 C PLUS	EM9550 Plus	EM9380 C / TOUCHSCREEN	EM9380 / TOUCHSCREEN	EM9350 C	EM9350	EM9280 C	EM9280	EM9250 C PREMIUM	EM9250 PREMIUM	EM9250 PROFESSIONAL	EM9250 Basic	EM9250 Basic BiKELINE								
NASADKI DYSTANSOWE																															
	ARF1 Specjalna flansa do kół F1 Akcesorium do kół F1 kompatybilne z mocowaniami Ferrari, McLaren i Toyota.	8-21100093	2 749,00	0	0	0	0	0	0	0	0	0	0	0	0	0	0	0	0	0	0	0	0								
	<table border="1"> <tr> <td>FIG</td> <td>Nasadka dystansowa L=60 mm</td> <td>4-105181</td> </tr> <tr> <td>FIP</td> <td>Nasadka dystansowa L=30 mm</td> <td>4-105171</td> </tr> <tr> <td>MF1</td> <td>Uchwyt do dystansu F1</td> <td>459932</td> </tr> </table>	FIG	Nasadka dystansowa L=60 mm	4-105181	FIP	Nasadka dystansowa L=30 mm	4-105171	MF1	Uchwyt do dystansu F1	459932																					
FIG	Nasadka dystansowa L=60 mm	4-105181																													
FIP	Nasadka dystansowa L=30 mm	4-105171																													
MF1	Uchwyt do dystansu F1	459932																													
MOCOWANIE KÓŁ - RÓŻNE AKCESORIA																															
	VGBP Koło ręczne do pierścienia mocowania koła.	802260682	457,00	-	-	-	-	0	-	0	-	0	-	0	-	0	-	0	-	0	0	0	0								
	Nasadka CBG do mocowania felg aluminiowych Ø 210 mm	802459564	361,00	0	0	0	0	0	0	0	0	0	0	0	0	0	0	0	0	0	0	0	0								
	<table border="1"> <tr> <td>OR</td> <td>Elastyczny gumowy pierścień</td> <td>462817</td> </tr> </table>	OR	Elastyczny gumowy pierścień	462817																											
OR	Elastyczny gumowy pierścień	462817																													
	Szybka blokada QLN . Możliwość montażu we wszystkich modelach z gwintowaną piastą Ø 40 mm. Akcesorium z pistoletem pneumatycznym do mocowania.	8-21100095	3 020,00	-	-	-	-	0	-	0	-	0	-	0	-	0	-	0	-	0	0	0	0								



■ = Standard 0 = Kompatybilne - = NIEkompatybilne

AKCESORIA DO WYWAŻAREK SAMOCHODOWYCH I MOTOCYKLOWYCH

	Opis	Kod	Cena netto	EYE-LIGHT PLUS	EM9980 C PLUS	EM9780 C PLUS	EM9680 C PLUS DOTLINE	EM9680 PLUS DOTLINE	EM9580 C PLUS TOUCH	EM9580 C PLUS	EM9550 C Plus	EM9550 Plus	EM9380 C / TOUCHSCREEN	EM9380 / TOUCHSCREEN	EM9350 C	EM9350	EM9280 C	EM9280	EM9250 C PREMIUM	EM9250 PREMIUM	EM9250 PROFESSIONAL	EM9250 Basic	EM9250 Basic BIKELINE
FLANSZE DO MOCOWANIA KÓŁ Z OTWOREM CENTRALNYM																							
	per cerchi a 5 fori. Range bloccaggio 95,25 - 180 mm ■ Ø 28 ■ Ø 22,5 ■ Ø 22,5 ■ Ø 19	PFF FASTPLATE 5 do felg 5-otworowych. Zakres mocowania: 95,25 ÷ 180 mm 8-21100294	2 526,00	○	○	○	○	○	○	○	○	○	○	○	○	○	○	○	○	○	○	○	○
	per cerchi a 3-4-6-8 fori. Range bloccaggio 95,25 - 180 mm ■ Ø 28 ■ Ø 22,5 ■ Ø 22,5 ■ Ø 19	PFF FASTPLATE 3-4-6-8 dla 3-4-6-8-otworów felgi. Zakres mocowania: 95,25 ÷ 180 mm 8-21100295	2 846,00	○	○	○	○	○	○	○	○	○	○	○	○	○	○	○	○	○	○	○	○
	8-21100296 PFF FASTPLATE KIT per cerchi a 3-4-5-6-8 fori. Range bloccaggio 95,25 - 180 mm ■ Ø 28 ■ Ø 22,5 ■ Ø 22,5 ■ Ø 19	PFF FASTPLATE KIT Do felg z 3-4-5-6-8 otworami. (zawiera 8-21100294 i 8-21100295) 8-21100296	5 084,00	○	○	○	○	○	○	○	○	○	○	○	○	○	○	○	○	○	○	○	○
	PFF-C SLEEVE HANDLE Tuleja do wyważarek z automatycznym mocowaniem. Do przykręcenia bezpośrednio do FASTPLATE, aby pracować wygodniej i szybciej 8-21100297	448,00	○	○	○	○	-	○	-	○	-	○	-	○	-	○	-	○	-	-	-	-	

■ = Standard ○ = Kompatybilne - = NIEkompatybilne

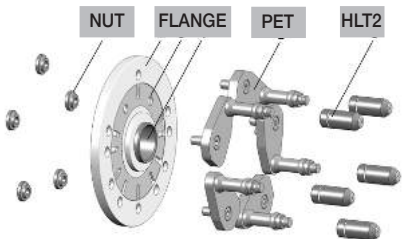
AKCESORIA DO WYWAŻAREK SAMOCHODOWYCH I MOTOCYKLOWYCH

Opis	Kod	Cena netto	EYE-LIGHT PLUS	EM9980 C PLUS	EM9780 C PLUS	EM9680 C PLUS DOTLINE	EM9680 PLUS DOTLINE	EM9580 C PLUS TOUCH	EM9580 C PLUS	EM9550 C PLUS	EM9550 Plus	EM9380 C / TOUCHSCREEN	EM9380 / TOUCHSCREEN	EM9350 C	EM9350	EM9280 C	EM9280	EM9250 C PREMIUM	EM9250 PREMIUM	EM9250 PROFESSIONAL	EM9250 BASIC	EM9250 BASIC BIKELINE
			FLANSZE DO MOCOWANIA KÓŁ Z OTWOREM CENTRALNYM																			
	FPF-2 BMW Uniwersalny zestaw flansz do kół z centralnym otworem (Ø 4x100/5x120/5x112).	8-21100145	2 271,00	O	O	O	O	O	O	O	O	O	O	O	O	O	O	O	O	O	O	O
	FPF Basic Uniwersalny zestaw flansz do kół z centralnym otworem Ø 40 mm.	8-21100152	3 148,00	O	O	O	O	O	O	O	O	O	O	O	O	O	O	O	O	O	O	O
	HLT2 Nakładka ø 22,5 L 58	4-109127																				
	PET Podstawowy platek	4-108097																				
	Zestaw z 2 pokrętłami obrotowymi	8-21100291	92,00	-	-	-	-	O	-	O	-	O	-	O	-	O	-	O	-	O	O	O
	FPF-3 BMW Specjalna flansza Ø 5x132mm BMW (28 502 909)	8-21100303	2 211,00	O	O	O	O	O	O	O	O	O	O	O	O	O	O	O	O	O	O	O

■ = Standard O = Kompatybilne - = NIEkompatybilne



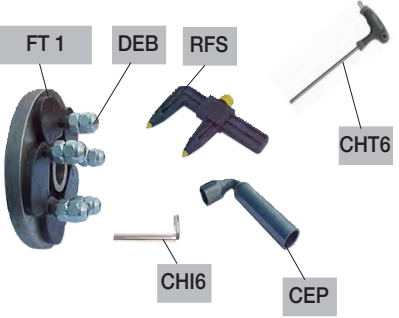
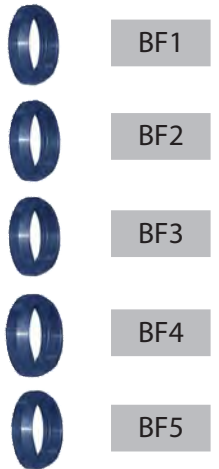

AKCESORIA DO WYWAŻAREK SAMOCHODOWYCH I MOTOCYKLOWYCH

Opis	Kod	Cena netto	EYE-LIGHT PLUS	EM9980 C PLUS	EM9780 C PLUS	EM9680 C PLUS DOTLINE	EM9680 PLUS DOTLINE	EM9580 C PLUS TOUCH	EM9580 C PLUS	EM9550 C Plus	EM9550 Plus	EM9380 C / TOUCHSCREEN	EM9380 / TOUCHSCREEN	EM9350 C	EM9350	EM9280 C	EM9280	EM9250 C PREMIUM	EM9250 PREMIUM	EM9250 PROFESSIONAL	EM9250 BASIC	EM9250 BASIC BIKELINE																
			FLANSZE DO MOCOWANIA KÓŁ Z OTWOREM CENTRALNYM I BEZ OTWORU CENTRALNEGO																																			
 <p>FRU-SA D.40 Flansza uniwersalna do kół z otworem centralnym lub bez.</p>	8-21100091	2 869,00	<input type="checkbox"/>	<input type="checkbox"/>	<input type="checkbox"/>	<input type="checkbox"/>	<input type="checkbox"/>	<input type="checkbox"/>	<input type="checkbox"/>	<input type="checkbox"/>	<input type="checkbox"/>	<input type="checkbox"/>	<input type="checkbox"/>	<input type="checkbox"/>	<input type="checkbox"/>	<input type="checkbox"/>	<input type="checkbox"/>	<input type="checkbox"/>	<input type="checkbox"/>	<input type="checkbox"/>	<input type="checkbox"/>	<input type="checkbox"/>																
			<table border="1"> <tr> <td>FT 1</td> <td>Korbówód ze sworzniem</td> <td>4-105873</td> </tr> <tr> <td>DEB</td> <td>Nakrętka stożkowa/kuliasta do mocowania koła</td> <td>321878</td> </tr> <tr> <td>CHT6</td> <td>Chiave esagonale a T CH 6</td> <td>4-105877</td> </tr> <tr> <td>RFS</td> <td>Suwmiarka</td> <td>441286</td> </tr> <tr> <td>CEP</td> <td>Klucz sześciokątny CH 22</td> <td>426517</td> </tr> <tr> <td>CHI 6</td> <td>Klucz sześciokątny CH 6</td> <td>600906</td> </tr> </table>	FT 1	Korbówód ze sworzniem	4-105873	DEB	Nakrętka stożkowa/kuliasta do mocowania koła	321878	CHT6	Chiave esagonale a T CH 6	4-105877	RFS	Suwmiarka	441286	CEP	Klucz sześciokątny CH 22	426517	CHI 6	Klucz sześciokątny CH 6	600906																	
FT 1	Korbówód ze sworzniem	4-105873																																				
DEB	Nakrętka stożkowa/kuliasta do mocowania koła	321878																																				
CHT6	Chiave esagonale a T CH 6	4-105877																																				
RFS	Suwmiarka	441286																																				
CEP	Klucz sześciokątny CH 22	426517																																				
CHI 6	Klucz sześciokątny CH 6	600906																																				
 <p>BVFF Zestaw 5 tulei do precyzyjnego centrowania na flanszy FRU.</p>	8-21100092	882,00	<input type="checkbox"/>	<input type="checkbox"/>	<input type="checkbox"/>	<input type="checkbox"/>	<input type="checkbox"/>	<input type="checkbox"/>	<input type="checkbox"/>	<input type="checkbox"/>	<input type="checkbox"/>	<input type="checkbox"/>	<input type="checkbox"/>	<input type="checkbox"/>	<input type="checkbox"/>	<input type="checkbox"/>	<input type="checkbox"/>	<input type="checkbox"/>	<input type="checkbox"/>	<input type="checkbox"/>	<input type="checkbox"/>	<input type="checkbox"/>																
			<table border="1"> <tr> <td>BF1</td> <td>Tuleja ø 55 Peugeot</td> <td>4-105110</td> </tr> <tr> <td>BF2</td> <td>Tuleja ø 58,1 Fiat Ritmo and Citröen CX/ Evasion, Peugeot 806</td> <td>4-105174</td> </tr> <tr> <td>BF3</td> <td>Tuleja ø 60,1 Renault</td> <td>4-105175</td> </tr> <tr> <td>BF4</td> <td>Tuleja ø 65 Peugeot, Citröen</td> <td>4-105176</td> </tr> <tr> <td>BF5</td> <td>Tuleja ø 57 BMW,VW, AUDI, SEAT</td> <td>4-106570</td> </tr> </table>	BF1	Tuleja ø 55 Peugeot	4-105110	BF2	Tuleja ø 58,1 Fiat Ritmo and Citröen CX/ Evasion, Peugeot 806	4-105174	BF3	Tuleja ø 60,1 Renault	4-105175	BF4	Tuleja ø 65 Peugeot, Citröen	4-105176	BF5	Tuleja ø 57 BMW,VW, AUDI, SEAT	4-106570																				
BF1	Tuleja ø 55 Peugeot	4-105110																																				
BF2	Tuleja ø 58,1 Fiat Ritmo and Citröen CX/ Evasion, Peugeot 806	4-105174																																				
BF3	Tuleja ø 60,1 Renault	4-105175																																				
BF4	Tuleja ø 65 Peugeot, Citröen	4-105176																																				
BF5	Tuleja ø 57 BMW,VW, AUDI, SEAT	4-106570																																				

■ = Standard O = Kompatybilne - = NIEkompatybilne

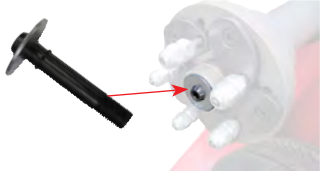

AKCESORIA DO WYWAŻAREK SAMOCHODOWYCH I MOTOCYKLOWYCH



Opis	Kod	Cena netto	EYE-LIGHT PLUS	EM9980 C PLUS	EM9780 C PLUS	EM9680 C PLUS DOTLINE	EM9680 PLUS DOTLINE	EM9580 C PLUS TOUCH	EM9580 C PLUS	EM9550 C Plus	EM9550 Plus	EM9380 C / TOUCHSCREEN	EM9380 / TOUCHSCREEN	EM9350 C	EM9350	EM9280 C	EM9280	EM9250 C PREMIUM	EM9250 PREMIUM	EM9250 PROFESSIONAL	EM9250 Basic	EM9250 Basic BikeLine	
			FLANSZE DO MOCOWANIA KÓŁ Z OTWOREM CENTRALNYM I BEZ OTWORU CENTRALNEGO																				
	Tarcza blokująca do tulei BVFF pod flanszę FRU-SA, do wyważarek z dociskiem ręcznym	8-21100207	101,00	-	-	-	-	O	-	O	-	O	-	O	-	O	-	O	-	O	O	O	O
	Tarcza blokująca do tulei BVFF pod flanszę FRU-SA, do wyważarek z automatycznym mocowaniem „C”.	8-21100208	101,00	O	O	O	O	-	O	-	O	-	O	-	O	-	O	-	O	-	-	-	-
	BCO Zestaw pięciu podkładek stożkowych do FRU-sa do stosowania z DCL i DEB przy obróbce otworów o średnicy większej niż 21 mm	802321387	252,00	O	O	O	O	O	O	O	O	O	O	O	O	O	O	O	O	O	O	O	O
	DCL Zestaw pięciu nakrętek stożkowych do felg aluminiowych z kołnierzem FRU-SA.	802322075	407,00	O	O	O	O	O	O	O	O	O	O	O	O	O	O	O	O	O	O	O	O
	DMS Zestaw pięciu nakrętek kulistych do felg aluminiowych z kołnierzem FRU-SA.	802322076	407,00	O	O	O	O	O	O	O	O	O	O	O	O	O	O	O	O	O	O	O	O

■ = Standard O = Kompatybilne - = NIEkompatybilne







www.corgi.pl

AKCESORIA DO WYWAŻAREK SAMOCHODOWYCH I MOTOCYKLOWYCH

	Opis	Kod	Cena netto	EYE-LIGHT PLUS	EM9980 C PLUS	EM9780 C PLUS	EM9680 C PLUS DOTLINE	EM9680 PLUS DOTLINE	EM9580 C PLUS TOUCH	EM9580 C PLUS	EM9550 C Plus	EM9550 Plus	EM9380 C / TOUCHSCREEN	EM9380 / TOUCHSCREEN	EM9350 C	EM9350	EM9280 C	EM9280	EM9250 C PREMIUM	EM9250 PREMIUM	EM9250 PROFESSIONAL	EM9250 BASIC	EM9250 BASIC BIKELINE	
	DC5 Zestaw pięciu specjalnych nakrętek do Citroena C5.	802262700	407,00	O	O	O	O	O	O	O	O	O	O	O	O	O	O	O	O	O	O	O	O	O
	SDR Zestaw pięciu specjalnych nakrętek do szybkiego mocowania kół.	802231479	1 439,00	O	O	O	O	O	O	O	O	O	O	O	O	O	O	O	O	O	O	O	O	O

■ = Standard O = Kompatybilne - = NIEkompatybilne

AKCESORIA DO WYWAŻAREK SAMOCHODOWYCH I MOTOCYKLOWYCH

Opis	Kod	Cena netto	EYE-LIGHT PLUS	EM9980 C PLUS	EM9780 C PLUS	EM9680 C PLUS DOTLINE	EM9680 PLUS DOTLINE	EM9580 C PLUS TOUCH	EM9580 C PLUS	EM9550 C Plus	EM9550 Plus	EM9380 C / TOUCHSCREEN	EM9380 / TOUCHSCREEN	EM9350 C	EM9350	EM9280 C	EM9280	EM9250 C PREMIUM	EM9250 PREMIUM	EM9250 PROFESSIONAL	EM9250 BASIC	EM9250 BASIC BIKELINE
			SYSTEM KALIBRACJI I WSPARCIA TECHNICZNEGO																			
	Kalibracja lasera BLCK-1 dla EM9980-C Plus, Eyclight Plus, EM9780 Plus	8-21120001	0	0	0	-	-	-	-	-	-	-	-	-	-	-	-	-	-	-	-	-
	Kabel szeregowy RS232 (mbu - mbe - seb).	8-21100224	147,00	0	0	0	0	0	0	0	0	0	0	0	0	0	0	0	0	0	0	0
	Adapter USB-RS232.	8-21100226	224,00	0	0	0	0	0	0	0	0	0	0	0	0	0	0	0	0	0	0	0
	SLUG próbka masy do kalibracji.	8-21100221	348,00	■	■	■	■	■	■	■	■	■	■	■	■	■	■	■	■	■	■	■
	Zestaw narzędzi.	8-21100197	448,00	0	0	0	0	0	0	0	0	0	0	0	0	0	0	0	0	0	0	0

■ = Standard O = Kompatybilne - = NIEkompatybilne

AKCESORIA DO WYWAŻAREK SAMOCHODOWYCH I MOTOCYKLOWYCH

AKCESORIA CENTRUJĄCE I MOCUJĄCE DO KÓŁ MOTOCYKLOWYCH

W gamie akcesoriów do wyważarek terenowych dostępny jest nowy BIKES UNIVERSAL KIT z różnymi dodatkowymi zestawami do centrowania i dynamicznego wyważania kół motocyklowych. Łatwy w instalacji i szybki w użyciu. Idealny do małych kół do skuterów o średnicy do 21 cali typu terenowego; nie zapominając o szerokim chopperze i monoleverach bez łożysk. Wyniki wyważania doskonałe!

Uniwersalna do wszystkich wyważarek w zakresie mocowania ręcznego i automatycznego.

PRZYKŁAD UŻYCIA



Wał ze stożkami centrującymi.

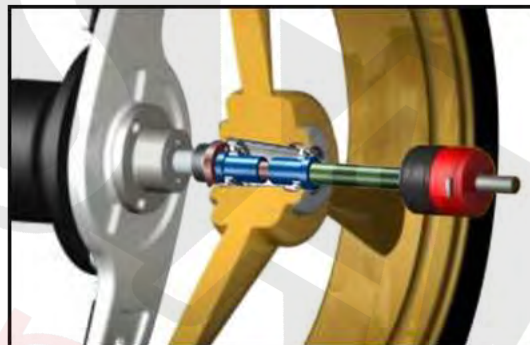

Wał z tulejami centrującymi.

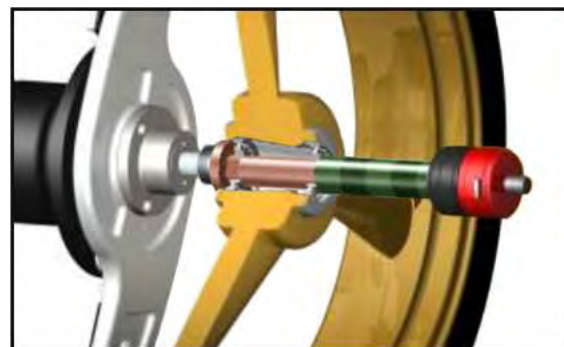

Wał motocykla o tej samej średnicy co łożysko pływające.

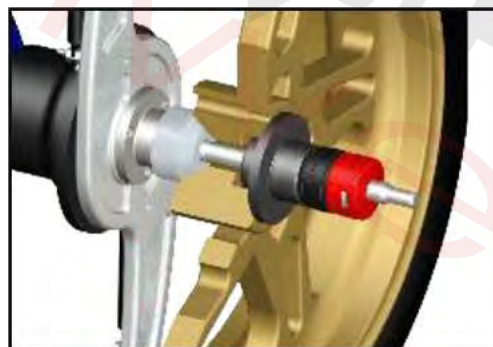

Wał ze specjalnym zestawem centrującym.

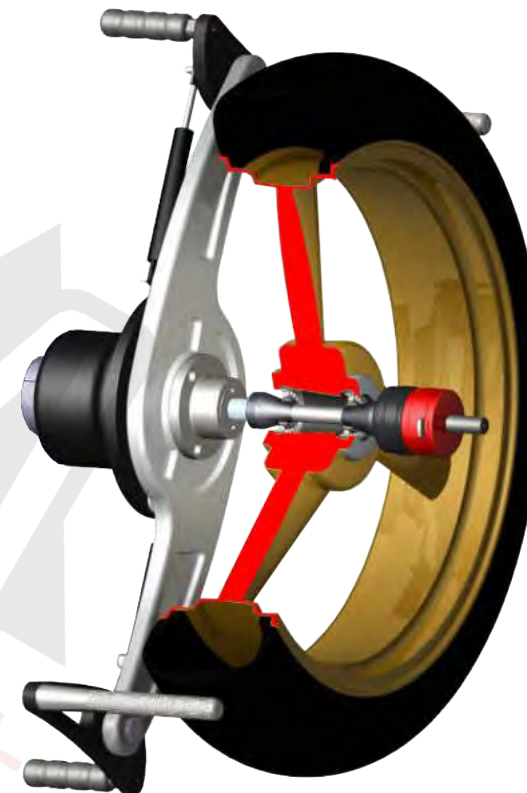

■ = Standard

○ = Kompatybilne

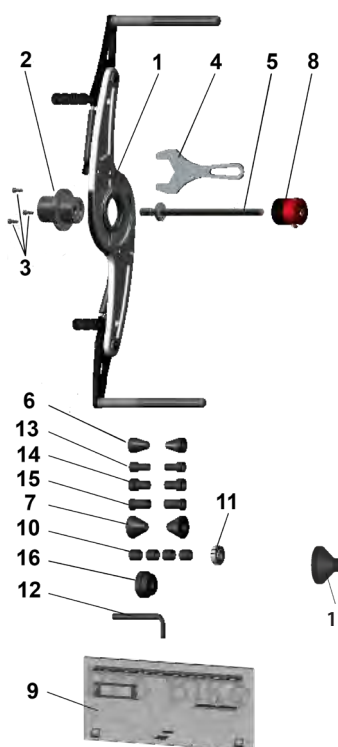
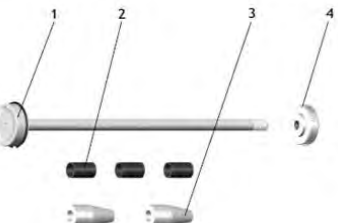

- = NIEkompatybilne

AKCESORIA DO WYWAŻAREK SAMOCHODOWYCH I MOTOCYKLOWYCH

Opis	Kod	Cena netto	EYE-LIGHT PLUS	EM9880 C PLUS	EM9780 C PLUS	EM9680 C PLUS DOTLINE	EM9680 PLUS DOTLINE	EM9580 C PLUS TOUCH	EM9580 C PLUS	EM9550 C Plus	EM9550 Plus	EM9380 C / TOUCHSCREEN	EM9380 / TOUCHSCREEN	EM9350 C	EM9350	EM9280 C	EM9280	EM9250 C PREMIUM	EM9250 PREMIUM	EM9250 PROFESSIONAL	EM9250 BASIC	EM9250 Basic BikeLine																																																			
STANDARDOWE AKCESORIA MOTOCYKLOWE																																																																									
	BIKE UNIVERSAL KIT 8-21120012 Podstawowe urządzenie do wyważania kół motocykli i skuterów. Wał uchwyty koła 14 mm. * Wskaźnik przedłużenia motocykla NIE jest wliczony w cenę	4 536,00	0	0	0	0	0	0	0	0	0	0	0	0	0	0	0	0	0	0	0	■																																																			
	<table border="1"> <tr> <td>1</td> <td>GRUPA PRZECIĄGAJĄCA</td> <td>3-03408</td> </tr> <tr> <td>2</td> <td>UCHWYT CYLINDRYCZNY</td> <td>3-03409</td> </tr> <tr> <td>3</td> <td>ŚRUBA Z GNIAZDEM SZEŚCIOKĄTNYM M 6X14</td> <td>3-03410</td> </tr> <tr> <td>4</td> <td>KLUCZ JEDNOGŁÓWKOWY SW50</td> <td>3-03411</td> </tr> <tr> <td>5</td> <td>WAŁ UCHWYTU KOŁA Ø 14 MM</td> <td>3-03412</td> </tr> <tr> <td>6</td> <td>STOŻEK CENTRUJĄCY 15÷30 MM</td> <td>3-03413</td> </tr> <tr> <td>7</td> <td>STOŻEK CENTRUJĄCY 16÷45 MM</td> <td>3-03414</td> </tr> <tr> <td>8</td> <td>SZYBKIE MOCOWANIE DO TRZPIENIA Ø 14 MM</td> <td>3-03415</td> </tr> <tr> <td>9</td> <td>PLYTA ŚCIENNA</td> <td>3-03416</td> </tr> <tr> <td>10</td> <td>KRÓTKI DYSTANS</td> <td>3-03417</td> </tr> <tr> <td>11</td> <td>M 14 NAKRĘTKA radełkowana</td> <td>3-03418</td> </tr> <tr> <td>12</td> <td>KLUCZ Z GNIAZDEM SZEŚCIOKĄTNYM SW4</td> <td>3-03419</td> </tr> <tr> <td>13</td> <td>TULEJA CENTRUJĄCA Ø 15 MM</td> <td>3-03420</td> </tr> <tr> <td>14</td> <td>TULEJA CENTRUJĄCA Ø 17 MM</td> <td>3-03421</td> </tr> <tr> <td>15</td> <td>TULEJA CENTRUJĄCA Ø 20 MM</td> <td>3-03422</td> </tr> <tr> <td>16</td> <td>TULEJA CENTRUJĄCA PIAGGIO</td> <td>3-03423</td> </tr> <tr> <td>17</td> <td>CIŚNIENIE BMW/HONDA</td> <td>3-03407</td> </tr> </table>	1	GRUPA PRZECIĄGAJĄCA	3-03408	2	UCHWYT CYLINDRYCZNY	3-03409	3	ŚRUBA Z GNIAZDEM SZEŚCIOKĄTNYM M 6X14	3-03410	4	KLUCZ JEDNOGŁÓWKOWY SW50	3-03411	5	WAŁ UCHWYTU KOŁA Ø 14 MM	3-03412	6	STOŻEK CENTRUJĄCY 15÷30 MM	3-03413	7	STOŻEK CENTRUJĄCY 16÷45 MM	3-03414	8	SZYBKIE MOCOWANIE DO TRZPIENIA Ø 14 MM	3-03415	9	PLYTA ŚCIENNA	3-03416	10	KRÓTKI DYSTANS	3-03417	11	M 14 NAKRĘTKA radełkowana	3-03418	12	KLUCZ Z GNIAZDEM SZEŚCIOKĄTNYM SW4	3-03419	13	TULEJA CENTRUJĄCA Ø 15 MM	3-03420	14	TULEJA CENTRUJĄCA Ø 17 MM	3-03421	15	TULEJA CENTRUJĄCA Ø 20 MM	3-03422	16	TULEJA CENTRUJĄCA PIAGGIO	3-03423	17	CIŚNIENIE BMW/HONDA	3-03407																					
	1	GRUPA PRZECIĄGAJĄCA	3-03408																																																																						
	2	UCHWYT CYLINDRYCZNY	3-03409																																																																						
	3	ŚRUBA Z GNIAZDEM SZEŚCIOKĄTNYM M 6X14	3-03410																																																																						
	4	KLUCZ JEDNOGŁÓWKOWY SW50	3-03411																																																																						
	5	WAŁ UCHWYTU KOŁA Ø 14 MM	3-03412																																																																						
	6	STOŻEK CENTRUJĄCY 15÷30 MM	3-03413																																																																						
	7	STOŻEK CENTRUJĄCY 16÷45 MM	3-03414																																																																						
	8	SZYBKIE MOCOWANIE DO TRZPIENIA Ø 14 MM	3-03415																																																																						
	9	PLYTA ŚCIENNA	3-03416																																																																						
	10	KRÓTKI DYSTANS	3-03417																																																																						
	11	M 14 NAKRĘTKA radełkowana	3-03418																																																																						
	12	KLUCZ Z GNIAZDEM SZEŚCIOKĄTNYM SW4	3-03419																																																																						
	13	TULEJA CENTRUJĄCA Ø 15 MM	3-03420																																																																						
	14	TULEJA CENTRUJĄCA Ø 17 MM	3-03421																																																																						
	15	TULEJA CENTRUJĄCA Ø 20 MM	3-03422																																																																						
16	TULEJA CENTRUJĄCA PIAGGIO	3-03423																																																																							
17	CIŚNIENIE BMW/HONDA	3-03407																																																																							
	Ø10mm Wałek centrujący extra-długi 230mm, do ewentualnego uzupełnienia kodu 8-21120012	8-21100257	1 174,00	0	0	0	0	0	0	0	0	0	0	0	0	0	0	0	0	0	0	0																																																			
	<table border="1"> <tr> <td>1</td> <td>WAŁ Ø 10 MM</td> <td>3-03864</td> </tr> <tr> <td>2</td> <td>SPACER</td> <td>3-03865</td> </tr> <tr> <td>3</td> <td>CENTERING CONE D. 12÷20 MM</td> <td>3-03866</td> </tr> <tr> <td>4</td> <td>RING NUT M 10</td> <td>3-03867</td> </tr> </table>	1	WAŁ Ø 10 MM	3-03864	2	SPACER	3-03865	3	CENTERING CONE D. 12÷20 MM	3-03866	4	RING NUT M 10	3-03867																																																												
	1	WAŁ Ø 10 MM	3-03864																																																																						
	2	SPACER	3-03865																																																																						
3	CENTERING CONE D. 12÷20 MM	3-03866																																																																							
4	RING NUT M 10	3-03867																																																																							

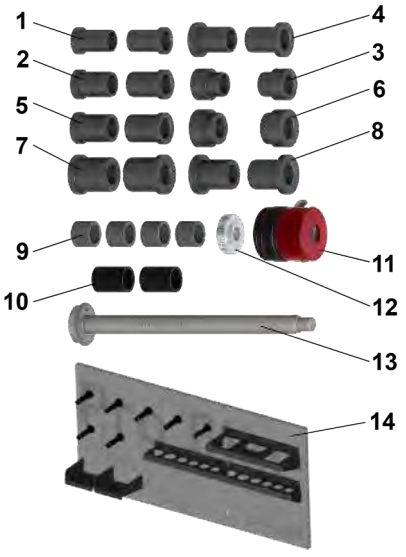

■ = Standard O = Kompatybilne - = NIEkompatybilne

AKCESORIA DO WYWAŻAREK SAMOCHODOWYCH I MOTOCYKLOWYCH

	Opis	Kod	Cena netto	EYE-LIGHT PLUS	EM9980 C PLUS	EM9780 C PLUS	EM9680 C PLUS DOTLINE	EM9680 PLUS DOTLINE	EM9580 C PLUS TOUCH	EM9580 C PLUS	EM9550 C Plus	EM9550 Plus	EM9380 C / TOUCHSCREEN	EM9380 / TOUCHSCREEN	EM9350 C	EM9350	EM9280 C	EM9280	EM9250 C PREMIUM	EM9250 PREMIUM	EM9250 PROFESSIONAL	EM9250 BASIC	EM9250 BASIC BIKE LINE																																									
STANDARDOWE AKCESORIA MOTOCYKLOWE																																																																
	PRA3 Motocyklowe przedłużenie czujnika. <u>Do modeli z klipsem.</u>	8-21100116	526,00	-	-	-	O	O	O	O	O	O	O	O	O	O	O	O	O	O	O	O	O																																									
	PRA4 Motocyklowe przedłużenie czujnika. <u>Do modeli bez klipsa.</u>	8-21100155	526,00	-	-	-	-	-	-	-	-	O	O	O	O	O	O	O	O	O	O	O	■																																									
	BIKE UPGRADE KIT 19 Dodatkowy moduł do BIKE UNIVERSAL KIT.	8-21120013	2 659,00	O	O	O	O	O	O	O	O	O	O	O	O	O	O	O	O	O	O	O	O																																									
	<table border="1"> <tbody> <tr> <td>1</td> <td>TULEJA CENTRUJĄCA D. 22 mm</td> <td>3-03383</td> </tr> <tr> <td>2</td> <td>TULEJA CENTRUJĄCA D. 25,4 mm</td> <td>3-03384</td> </tr> <tr> <td>3</td> <td>TULEJA CENTRUJĄCA D. 25 mm</td> <td>3-03385</td> </tr> <tr> <td>4</td> <td>TULEJA CENTRUJĄCA D. 26 mm</td> <td>3-03386</td> </tr> <tr> <td>5</td> <td>TULEJA CENTRUJĄCA D. 28 mm</td> <td>3-03387</td> </tr> <tr> <td>6</td> <td>TULEJA CENTRUJĄCA D. 32 mm</td> <td>3-03388</td> </tr> <tr> <td>7</td> <td>TULEJA CENTRUJĄCA D. 35 mm</td> <td>3-03389</td> </tr> <tr> <td>8</td> <td>TULEJA CENTRUJĄCA D. 30 mm</td> <td>3-03390</td> </tr> <tr> <td>9</td> <td>KRÓTKI DYSTANS Śr. 20 mm</td> <td>3-03391</td> </tr> <tr> <td>10</td> <td>HARLEY D. PRZEŁĄCZNIK CIŚNIENIA</td> <td>3-03392</td> </tr> <tr> <td>11</td> <td>SZYBKIE MOCOWANIE DO WAŁU D. 19</td> <td>3-03393</td> </tr> <tr> <td>12</td> <td>M 14 NAKRĘTKA radełkowana</td> <td>3-03418</td> </tr> <tr> <td>13</td> <td>WAŁ UCHWYTU KOŁA Śr. 19 mm</td> <td>3-03396</td> </tr> <tr> <td>14</td> <td>PŁYTA ŚCIENNA</td> <td>3-03395</td> </tr> </tbody> </table>	1	TULEJA CENTRUJĄCA D. 22 mm	3-03383	2	TULEJA CENTRUJĄCA D. 25,4 mm	3-03384	3	TULEJA CENTRUJĄCA D. 25 mm	3-03385	4	TULEJA CENTRUJĄCA D. 26 mm	3-03386	5	TULEJA CENTRUJĄCA D. 28 mm	3-03387	6	TULEJA CENTRUJĄCA D. 32 mm	3-03388	7	TULEJA CENTRUJĄCA D. 35 mm	3-03389	8	TULEJA CENTRUJĄCA D. 30 mm	3-03390	9	KRÓTKI DYSTANS Śr. 20 mm	3-03391	10	HARLEY D. PRZEŁĄCZNIK CIŚNIENIA	3-03392	11	SZYBKIE MOCOWANIE DO WAŁU D. 19	3-03393	12	M 14 NAKRĘTKA radełkowana	3-03418	13	WAŁ UCHWYTU KOŁA Śr. 19 mm	3-03396	14	PŁYTA ŚCIENNA	3-03395																					
1	TULEJA CENTRUJĄCA D. 22 mm	3-03383																																																														
2	TULEJA CENTRUJĄCA D. 25,4 mm	3-03384																																																														
3	TULEJA CENTRUJĄCA D. 25 mm	3-03385																																																														
4	TULEJA CENTRUJĄCA D. 26 mm	3-03386																																																														
5	TULEJA CENTRUJĄCA D. 28 mm	3-03387																																																														
6	TULEJA CENTRUJĄCA D. 32 mm	3-03388																																																														
7	TULEJA CENTRUJĄCA D. 35 mm	3-03389																																																														
8	TULEJA CENTRUJĄCA D. 30 mm	3-03390																																																														
9	KRÓTKI DYSTANS Śr. 20 mm	3-03391																																																														
10	HARLEY D. PRZEŁĄCZNIK CIŚNIENIA	3-03392																																																														
11	SZYBKIE MOCOWANIE DO WAŁU D. 19	3-03393																																																														
12	M 14 NAKRĘTKA radełkowana	3-03418																																																														
13	WAŁ UCHWYTU KOŁA Śr. 19 mm	3-03396																																																														
14	PŁYTA ŚCIENNA	3-03395																																																														

■ = Standard O = Kompatybilne - = NIEkompatybilne

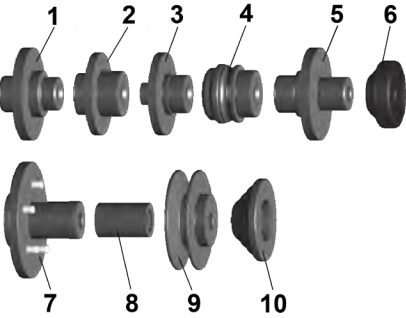
AKCESORIA DO WYWAŻAREK SAMOCHODOWYCH I MOTOCYKLOWYCH

Opis	Kod	Cena netto	EYE-LIGHT PLUS	EM9980 C PLUS	EM9780 C PLUS	EM9680 C PLUS DOTLINE	EM9680 PLUS DOTLINE	EM9580 C PLUS TOUCH	EM9580 C PLUS	EM9550 C Plus	EM9550 Plus	EM9380 C / TOUCHSCREEN	EM9380 / TOUCHSCREEN	EM9350 C	EM9350	EM9280 C	EM9280	EM9250 C PREMIUM	EM9250 PREMIUM	EM9250 PROFESSIONAL	EM9250 BASIC	EM9250 BASIC BikeLine																														
			STANDARDOWE AKCESORIA MOTOCYKLOWE																																																	
 <p>BIKE MONOLEVER KIT 19 Dodatkowy moduł do zestawu BIKE UPGRADE KIT do kół motocyklowych z monoleverem.</p> <table border="1"> <tr> <td>1</td> <td>TULEJA CENTRUJĄCA DUCATI/TRIUMPH</td> <td>3-03397</td> </tr> <tr> <td>2</td> <td>TULEJA CENTRUJĄCA MV AGUSTA/HONDA</td> <td>3-03398</td> </tr> <tr> <td>3</td> <td>TULEJA CENTRUJĄCA HONDA GL 1800 / NTV 650</td> <td>3-03399</td> </tr> <tr> <td>4</td> <td>TULEJA CENTRUJĄCA APRILIA/BMW/YAMAHA</td> <td>3-03400</td> </tr> <tr> <td>5</td> <td>TULEJA CENTRUJĄCA TRIUMPH/HONDA VFR1200</td> <td>3-03401</td> </tr> <tr> <td>6</td> <td>CZĘŚĆ CIŚNIENIA</td> <td>3-03402</td> </tr> <tr> <td>7</td> <td>FLANSA CENTRUJĄCA KTM SUPERDUKE+TRIUMPH</td> <td>3-03403</td> </tr> <tr> <td>8</td> <td>TULEJA DYSTANSOWA, DŁUGA</td> <td>3-03404</td> </tr> <tr> <td>9</td> <td>TARCZA CENTRUJĄCA BMW II (OD ROKU PRODUKCJI 2005) RÓWNIEŻ R V1200 GS</td> <td>3-03405</td> </tr> <tr> <td>10</td> <td>TARCZA CENTRUJĄCA BMW I (OD ROKU PRODUKCJI 2005) APART R V1200 GS, MOTO GUZZI (OD 2008 ROKU) (Ø WEWNĘTRZNA 14)</td> <td>3-03406</td> </tr> </table>	1	TULEJA CENTRUJĄCA DUCATI/TRIUMPH	3-03397	2	TULEJA CENTRUJĄCA MV AGUSTA/HONDA	3-03398	3	TULEJA CENTRUJĄCA HONDA GL 1800 / NTV 650	3-03399	4	TULEJA CENTRUJĄCA APRILIA/BMW/YAMAHA	3-03400	5	TULEJA CENTRUJĄCA TRIUMPH/HONDA VFR1200	3-03401	6	CZĘŚĆ CIŚNIENIA	3-03402	7	FLANSA CENTRUJĄCA KTM SUPERDUKE+TRIUMPH	3-03403	8	TULEJA DYSTANSOWA, DŁUGA	3-03404	9	TARCZA CENTRUJĄCA BMW II (OD ROKU PRODUKCJI 2005) RÓWNIEŻ R V1200 GS	3-03405	10	TARCZA CENTRUJĄCA BMW I (OD ROKU PRODUKCJI 2005) APART R V1200 GS, MOTO GUZZI (OD 2008 ROKU) (Ø WEWNĘTRZNA 14)	3-03406	8-21120014	4 088,00	0	0	0	0	0	0	0	0	0	0	0	0	0	0	0	0	0	0	0	0
	1	TULEJA CENTRUJĄCA DUCATI/TRIUMPH	3-03397																																																	
	2	TULEJA CENTRUJĄCA MV AGUSTA/HONDA	3-03398																																																	
	3	TULEJA CENTRUJĄCA HONDA GL 1800 / NTV 650	3-03399																																																	
	4	TULEJA CENTRUJĄCA APRILIA/BMW/YAMAHA	3-03400																																																	
	5	TULEJA CENTRUJĄCA TRIUMPH/HONDA VFR1200	3-03401																																																	
	6	CZĘŚĆ CIŚNIENIA	3-03402																																																	
	7	FLANSA CENTRUJĄCA KTM SUPERDUKE+TRIUMPH	3-03403																																																	
	8	TULEJA DYSTANSOWA, DŁUGA	3-03404																																																	
	9	TARCZA CENTRUJĄCA BMW II (OD ROKU PRODUKCJI 2005) RÓWNIEŻ R V1200 GS	3-03405																																																	
	10	TARCZA CENTRUJĄCA BMW I (OD ROKU PRODUKCJI 2005) APART R V1200 GS, MOTO GUZZI (OD 2008 ROKU) (Ø WEWNĘTRZNA 14)	3-03406																																																	
 <p>Ø14mm Wałek centrujący extra-długi 318mm, do ewentualnego uzupełnienia kodu 8-21120012</p>	8-21120016	1 595,00	0	0	0	0	0	0	0	0	0	0	0	0	0	0	0	0	0	0	0	0																														
 <p>Ø19mm Wałek centrujący extra-długi 365mm, do ewentualnego uzupełnienia kodu 8-21120013</p>	8-21120017	1 741,00	0	0	0	0	0	0	0	0	0	0	0	0	0	0	0	0	0	0	0	0																														

■ = Standard O = Kompatybilne - = NIEkompatybilne



www.corgi.pl

EM 9050 SPACESAVER



STANDARDOWE AKCESORIA



Ø 42÷103,5 mm



x3



DLA WERSJI
HAND SPIN



DLA WERSJI Z
NAPEDEM



Kod	Zasilanie	Opis	Cena netto
0-21109051/16	200-230V/1Ph/50-60Hz	EM 9050 SPACESAVER - HAND SPIN Przenośna wyważarka do opon samochodowych o niewielkich wymiarach i wadze; specjalnie zaprojektowane do obsługi mobilnej i warsztatów o ograniczonej przestrzeni roboczej. Ręczna wersja. Automatyczne wykrywanie rozmiaru kół SmartArm 28". Hamulec obsługiwany dźwignią.	12 246,00
0-21109050/16	200-230V/1Ph/50-60Hz	EM 9050 SPACESAVER - MOTORIZED Przenośna wyważarka do opon samochodowych, kompaktowa pod względem wymiarów i wagi; specjalnie zaprojektowane do obsługi mobilnej i warsztatów o ograniczonej przestrzeni roboczej. Wersja z napędem elektrycznym uruchamiana dźwignią. Automatyczne wykrywanie rozmiarów kół SmartArm 28". Hamulec obsługiwany dźwignią.	13 657,00

EM 9050 - TILT UP - HAND SPIN



STANDARDOWE AKCESORIA



Kod	Zasilanie	Opis	Cena netto
0-21109052/16	200-230V/1Ph/50-60Hz	EM9050 SPACESAVER - TILT UP - HAND SPIN Specjalna wersja do obsługi mobilnej. Idealny do pracy wewnątrz furgonetki dzięki możliwości odchylenia jednostki pomiarowej do pozycji pionowej. Wersja z ręcznym obrotem, automatyczne wykrywanie rozmiaru kół SmartArm. Hamulec obsługiwany dźwignią.	13 657,00

EM 9050 - SLIDE - Motorized Spin



STANDARDOWE AKCESORIA



Kod	Zasilanie	Opis	Cena netto
0-21109053/16	200-230V/1P _H /50-60Hz	EM 9050 SPACESAVER - SLIDE - MOTORIZED Specjalna wersja do obsługi mobilnej. Można go wyjąć z bocznych drzwi i umożliwia wygodną pracę poza furgonetką. Wersja z napędem silnikowym uruchamiana dźwignią, automatyczne wykrywanie rozmiaru kół SmartArm. Hamulec obsługiwany dźwignią.	16 124,00

EM 9050 WORKBENCH



STANDARDOWE AKCESORIA

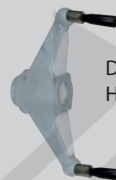

DLA WERSJI
HAND SPIN

Ø 42÷103,5 mm

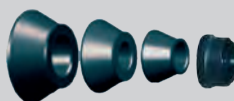

x3







DLA WERSJI Z
NAPĘDEM



Kod	Zasilanie	Opis	Cena netto
0-21109057/16	100÷230/1P _H /50-60Hz	EM9050 WORKBENCH - Hand Spin. Niezwykle kompaktowa wyważarka do kół. Można ją przymocować do stołu warsztatowego. Dla hobbystów, małych warsztatów lub do serwisu mobilnego. Automatyczne wykrywanie rozmiaru koła SmartArm 28". Hamulec sterowany dźwignią. Wersja ręczna.	11 776,00
0-21109056/16	200÷230/1P _H /50-60Hz	EM9050 WORKBENCH - Motorized Spin. Niezwykle kompaktowa wyważarka do kół. Można ją przymocować do stołu warsztatowego. Dla hobbystów, małych warsztatów lub serwisu mobilnego. Automatyczne wykrywanie rozmiaru koła SmartArm 28". Hamulec sterowany dźwignią. Wersja z napędem silnikowym uruchamiana dźwignią	13 082,00

ZALECANE AKCESORIA DO SERWISU MOBILNEGO

	Opis	Kod	Cena netto	EM 9050 HS	EM 9050 Motor	EM 9050 Tilt	EM 9050 Slide	EM 9050 WB HS	EM 9050 WB Motor
	PL - idealna stopa do montażu bez kotwienia do podłoża; dostępny w kolorze czerwonym (/16) i szarym (/90) (nie dotyczy wersji EM9050 SLIDE)	8-21101100/XX	448,00	O	O	O	-	-	-
	Wózek ułatwiający obsługę (nie dotyczy wersji EM9050 SLIDE)	8-21101200	302,00	O	O	O	-	-	-
	AL12 - zestaw zasilacza 12v (tylko dla wersji EM9050 Hand Spin)	8-21101000	425,00	O	-	O	-	O	-
	Zestaw TILT do uzyskania wersji TILT; Idealny do pracy wewnątrz samochodu dostawczego dzięki możliwości pochYLENIA jednostki pomiarowej do pozycji pionowej	8-21101300	1 448,00	O	O	-	-	-	-
	Zestaw KFTU — zestaw do mocowania do podłogi (dostarczany już z EM9050 Hand Spin, EM 9050 Motorized Spin, EM 9050 TILT UP)	8-21101010	265,00	■	■	■	-	-	-

■ = Standard O = Kompatybilne - = NIEkompatybilne

ZALECANE AKCESORIA DO SERWISU MOBILNEGO

	Opis	Kod	Cena netto	EM 9050 HS	EM 9050 Motor	EM 9050 Tilt	EM 9050 Slide	EM 9050 WB HS	EM 9050 WB Motor																		
	ARF Akcesorium do kół terenowych Ø 102,5÷118,5 mm.	8-21100080	530,00	O	O	O	O	O	O																		
	MLC Obrót uchwyty do flanszy FRU-SA	802244344	183,00	O	-	O	-	O	-																		
	DX/CFB Akcesorium centrujące do samochodów dostawczych i terenowych Ø 117÷173 mm. <table border="1" style="width: 100%; border-collapse: collapse;"> <tr> <td style="width: 10%;">DX1</td> <td style="width: 70%;">Nasadka dystansowa</td> <td style="width: 20%;">4-107426</td> </tr> <tr> <td>CF1</td> <td>Stożek do samochodów dostawczych ø 117÷147 mm</td> <td>4-107423</td> </tr> <tr> <td>CF2</td> <td>Stożek do samochodów dostawczych ø 143÷173 mm</td> <td>4-107424</td> </tr> </table>	DX1	Nasadka dystansowa	4-107426	CF1	Stożek do samochodów dostawczych ø 117÷147 mm	4-107423	CF2	Stożek do samochodów dostawczych ø 143÷173 mm	4-107424	8-21100141	1 709,00	O	O	O	O	O	O									
DX1	Nasadka dystansowa	4-107426																									
CF1	Stożek do samochodów dostawczych ø 117÷147 mm	4-107423																									
CF2	Stożek do samochodów dostawczych ø 143÷173 mm	4-107424																									
	SBC Zestaw sześciu tulei centrujących ø 40 mm. <table border="1" style="width: 100%; border-collapse: collapse;"> <tr> <td style="width: 10%;">B1</td> <td style="width: 70%;">AUDI, BMW, Chrysler, Opel, Rover, Seat, VW, Daewoo, Galaxy (Ford), Lotus, British-Leyland, Smart (Mercedes), Skoda</td> <td style="width: 20%;">4-105075</td> </tr> <tr> <td>B2</td> <td>Citröen, Hyundai, Lancia, Maserati, Mazda, Mercedes, Mitsubishi, Nissan, Opel, Peugeot, Saab, Volvo.</td> <td>4-105076</td> </tr> <tr> <td>B3</td> <td>BMW, Jaguar, Aston Martin.</td> <td>4-105077</td> </tr> <tr> <td>B4</td> <td>Ford, Honda, Rover</td> <td>4-105078</td> </tr> <tr> <td>B5</td> <td>Autobianchi, Alfa Romeo, Citröen, Fiat, Lada, Lancia, Jalbot, Biturbo (Maserati), Mazda, Nissan, Peugeot, Porsche, Renault, 2600-3500 serie (Rover), Seat =>90, Skoda, Toyota.</td> <td>4-105079</td> </tr> <tr> <td>B7</td> <td>Citröen, Daihatsu, Honda, Kia, Mazda, Mitsubishi, Peugeot, Rover, Subaru, Toyota, Agila (Opel), Suzuki, Hyuday.</td> <td>4-105080</td> </tr> </table>	B1	AUDI, BMW, Chrysler, Opel, Rover, Seat, VW, Daewoo, Galaxy (Ford), Lotus, British-Leyland, Smart (Mercedes), Skoda	4-105075	B2	Citröen, Hyundai, Lancia, Maserati, Mazda, Mercedes, Mitsubishi, Nissan, Opel, Peugeot, Saab, Volvo.	4-105076	B3	BMW, Jaguar, Aston Martin.	4-105077	B4	Ford, Honda, Rover	4-105078	B5	Autobianchi, Alfa Romeo, Citröen, Fiat, Lada, Lancia, Jalbot, Biturbo (Maserati), Mazda, Nissan, Peugeot, Porsche, Renault, 2600-3500 serie (Rover), Seat =>90, Skoda, Toyota.	4-105079	B7	Citröen, Daihatsu, Honda, Kia, Mazda, Mitsubishi, Peugeot, Rover, Subaru, Toyota, Agila (Opel), Suzuki, Hyuday.	4-105080	8-21100082	1 307,00	O	O	O	O	O	O
B1	AUDI, BMW, Chrysler, Opel, Rover, Seat, VW, Daewoo, Galaxy (Ford), Lotus, British-Leyland, Smart (Mercedes), Skoda	4-105075																									
B2	Citröen, Hyundai, Lancia, Maserati, Mazda, Mercedes, Mitsubishi, Nissan, Opel, Peugeot, Saab, Volvo.	4-105076																									
B3	BMW, Jaguar, Aston Martin.	4-105077																									
B4	Ford, Honda, Rover	4-105078																									
B5	Autobianchi, Alfa Romeo, Citröen, Fiat, Lada, Lancia, Jalbot, Biturbo (Maserati), Mazda, Nissan, Peugeot, Porsche, Renault, 2600-3500 serie (Rover), Seat =>90, Skoda, Toyota.	4-105079																									
B7	Citröen, Daihatsu, Honda, Kia, Mazda, Mitsubishi, Peugeot, Rover, Subaru, Toyota, Agila (Opel), Suzuki, Hyuday.	4-105080																									
	VGBP Uchwyt do nakrętki koła	802260682	457,00	O	■	O	■	O	■																		

■ = Standard O = Kompatybilne - = NIEkompatybilne

ZALECANE AKCESORIA DO SERWISU MOBILNEGO

	Opis	Kod	Cena netto	EM 9050 HS	EM 9050 Motor	EM 9050 Tilt	EM 9050 Slide	EM 9050 WB HS	EM 9050 WB Motor
	WYKRYWANIE ROZMIARÓW KOŁA cyfrowy miernik do pozyskiwania średnicy i odległości. Maksymalna precyzja przy wykorzystaniu systemu FSP, który automatycznie dobiera odpowiedni program wyważania.	8-21120022	1 033,00	O	O	O	O	O	O

SAMINWEST

■ = Standard O = Kompatybilne - = NIEkompatybilne



www.corghi.pl



SAMINWEST
ul. Rybnicka 77a, 44-285 Rzuchów
tel.: 32-430-10-62
saminwest@saminwest.com
www.corghi.pl

PIERWSZY AUTORYZOWANY PRZEDSTAWICIEL MARKI CORGHI NIEPRZERWANIE OD 30LAT

