



SAM
inwest



WYWAŻARKI DO KÓŁ OSOBOWYCH

CENNIK 11.2024



**PIERWSZY AUTORYZOWANY DYSTRYBUTOR I
PRZEDSTAWICIEL MARKI CORGHI W POLSCE**

Wersja
PL

O MARCE

CORGHI (1954) jest największym producentem sprzętu do obsługi kół. Obecna gama oferowanych produktów zawiera montażownice automatyczne, wyważarki do kół, urządzenia do ustawiania geometrii kół, podnośniki, linie diagnostyczne, inny sprzęt diagnostyczny oraz urządzenia dodatkowe. Wraz z partnerami, Corghi posiada największą na świecie sieć dystrybucji sprzętu do obsługi samochodów. Swoim zasięgiem obejmuje 137 krajów, posiada ponadto swe filie w Niemczech, Meksyku i Chinach, a w 2009 roku została otwarta filia w Stanach Zjednoczonych. Od roku 2018 zmieniono nazwę firmy na Nexion SPA. Marka Corghi i siedziba pozostała bez zmian.

MISJA FIRMY

Klienci są najważniejsi – naszym najważniejszym priorytetem jest zadowolenie klienta z jakości, dystrybucji i innowacyjności produktów.

Całościowe i kompleksowe rozwiązania we wszystkim co robimy – jest kluczem do budowania silnych relacji partnerskich ze współpracownikami, klientami, dostawcami a naszą firmą.

Ciągle udoskonalanie – jest bardzo ważnym aspektem naszej działalności.

Innowacyjność dla rozwoju – kreatywne i całościowe rozwiązania prowadzą nas do rozwoju.

Najlepsze talenty dla zespołu – nasza kadra jest wysoko wykwalifikowana, kreatywna, przedsiębiorcza i wie jak osiągnąć najlepsze efekty.

INNOWACYJNOŚĆ

Corghi może także poszczycić się nagrodami za innowacyjność technologiczną w swoim sektorze, przyznanymi przez niezależne organizacje certyfikujące i doceniające ciągle starania i wysiłki w osiągnięciu rezultatów w innowacyjności. Innowacyjności, która pozwala specjalistom z branży oponiarskiej oraz branży automechaniki na pełny profesjonalizm w swej dziedzinie w odpowiedzi na wszelkie nowinki techniczne związane z projektowaniem samochodów i opon.

CENNIK

Producent zastrzega sobie prawo do zmiany parametrów swoich produktów w dowolnym czasie. Informacje zawarte w niniejszym cenniku nie są prawnie wiążące i nie stanowią oferty handlowej, w tym w rozumieniu art. 66 § 1 Kodeksu cywilnego. Zdjęcia mają charakter poglądowy i mogą różnić się od oryginału. Zastrzegamy sobie prawo do zmian cen sprzedaży w przypadku, gdy wartość kursu sprzedaży EUR w NBP przekroczy 5,1000 PLN/€. Kopiowanie oraz jakiegokolwiek modyfikowane zabronione. Cennik ważny od 10.11.2024 aż do ukazania się nowej wersji.

*Gwarantujemy najlepsze ceny Marki
CORGHI w kraju. Wysokie rabaty
dla każdego klienta na maszyny
najwyższej jakości.
Znajdź lepszą ofertę na
rynku a sprostamy każdej*

*Ceny podane w niniejszym cenniku są
cenami katalogowymi netto bez rabatu. Standardowy
rabat to **-20%** odliczany od cen katalogowych netto.*

*Skontaktuj się z nami aby otrzymać coś
więcej i dowiedzieć się o naszych promocjach*

Tel. 601 555 541



Wyjaśnienia ikon i opisy funkcji do nich przypisanych



1 SYSTEM OSZCZĘDZANIA CIĘŻARKÓW

Jest to oprogramowanie zawierające system oszczędzania ciężarków minimalizujący czas pracy i ilość aplikowanych ciężarków zmniejszając koszty i zagrożenie dla środowiska.



2 EKRAN DOTYKOWY

Graficzny interfejs, oraz dotykowa technologia ułatwiają i przyspieszają pracę i wybór programów.



3 WSKAŹNIK APLIKOWANIA CIĘŻARKÓW

Ciężarki klejone mogą być łatwo aplikowane w miejscu wskazanym przez wskaźnik laserowy.



4 AUTOMATYCZNE MOCOWANIE KOŁA

Nowy elektromechaniczny system mocowania skracający czas i zwiększający precyzję centrowania koła.



5 INTELIGENTNE POZYCJONOWANIE

Specjalne narzędzie diagnostyczne. Po zbadaniu wszystkich kół pojazdu pod kątem zużycia bieżnika, starcia kierunkowego czy niedowagi system proponuje odpowiednie rozłożenie kół na pojeździe zwiększające komfort i bezpieczeństwo jazdy. Test drogowy bez testu obciążeniowego.



6 OŚWIETLENIE LED

Ułatwia pracę przy czyszczeniu miejsca aplikacji ciężarka i procesu klejenia.



7 KOMPLETNA DIAGNOSTYKA KOŁA

Diagnostyczny program automatycznie mierzy następujące parametry za pomocą sonaru:

- precyzyjny pomiar bicia koła we wszystkich płaszczyznach oraz kalkulacja optymalnego spasowania felga-opona, rozwiązujący większość problemów wibracji powodowanych ogumieniem.
- ścięcie opony, który powoduje że pojazd jest stale ciągnięty w jedną stronę w czasie jazdy w linii prostej
- głębokość bieżnika.



8 OSZCZĘDNOŚĆ MIEJSCA

Pochylny przód maszyny dla łatwiejszego dostępu do wnętrza koła, oraz osłona koła zaprojektowana tak, aby zminimalizować potrzebne miejsce, tzw. „Zero Space”.



9 PRZYCISK WIELOFUNKCYJNY I STÓŁ NA CIĘŻARKI

Stół na ciężarki jest ergonomiczny i funkcjonalny, może pomieścić różne rodzaje ciężarków oraz narzędzi. Przycisk wielofunkcyjny jest prosty i szybki oraz ułatwia wybór programów.



10 W PEŁNI AUTOMATYCZNA

Nie wymaga żadnych operacji ręcznych od operatora.



11 TRYB UKRYTEGO CIĘŻARU

Nowy program ukrytego ciężaru tzw. "Hidden Weight" do podziału ciężarków na dwie równoważne wagi ukryte za szprychami. Całkowicie automatyczna operacja.



12 WYKRYWANIE WYMIARÓW KÓŁ

cyfrowy miernik do akwizycji średnicy i odległości z funkcją FSP (Fast Selection Program) i nowym zintegrowanym wskaźnikiem LaserBlade: funkcja FSP automatycznie aktywuje program wyważania, unikając wyboru za pomocą klawiatury, podczas gdy wskaźnik LaserBlade (wewnątrz ramienia pomiarowego) bezbłędnie i przy wyjątkowo dobrej widoczności pomaga operatorowi w wyborze poziomu w aluminiowej feldze.



13 AUTOMATYCZNY POMIAR SZEROKOŚCI KOŁA

Automatyczny czujnik AWD (Auto width Device) do bezdotykowego pomiaru szerokości koła (opcjonalny)



14 PNEUMATYCZNE MOCOWANIE KOŁA

Pneumatyczny system mocowania koła za pomocą pedału.



15 AUTOMATYCZNE POZYCJONOWANIE

Automatyczne zatrzymanie koła następuje w punkcie, gdzie wyważony ciężar jest pozycjonowany (RPA) oraz stosowany jest elektryczny hamulec

SPIS TREŚCI

Kliknij na produkt, lub stronę, aby się na nią przenieść.

WYWAŻARKI DO SAMOCHODÓW OSOBOWYCH/VAN/BUS

| | |
|-----------------------------------------------|----|
| EYE-LIGHT PLUS DIAGNOSTICLINE | 6 |
| EM 9980C PLUS DIAGNOSTICLINE | 7 |
| EM 9780C PLUS AUTOMATICLINE | 8 |
| EM 9580 C PLUS TOUCHSCREEN | 9 |
| EM 9580 PLUS TOUCHSCREEN | 10 |
| EM 9580 C PLUS LASERLINE | 11 |
| EM 9580 PLUS LASERLINE | 12 |
| EM 9550 C PLUS LASERLINE | 13 |
| EM 9550 PLUS LASERLINE | 14 |
| EM 9380 C XLINE TOUCHSCREEN | 15 |
| EM 9380 C XLINE | 15 |
| EM 9380 XLINE TOUCHSCREEN | 16 |
| EM 9380 XLINE | 16 |
| EM 9350 C XLINE | 17 |
| EM 9350 XLINE | 18 |
| EM 9280 C COMPACTLINE | 19 |
| EM 9280 COMPACTLINE | 20 |
| EM 9250 COMPACTLINE | 21 |

WYWAŻARKI DO MOTOCYKLI

| | |
|----------------------------------------|----|
| EM 9250 BASIC BIKELINE | 22 |
|----------------------------------------|----|

| | |
|-------------------------------------------------------------|----|
| AKCESORIA DLA WYWAŻAREK SAMOCHODOWYCH I DO MOTOCYKLI | 24 |
|-------------------------------------------------------------|----|

WYWAŻARKI DO MOBILNYCH SERWISÓW SAMOCHODOWYCH

| | |
|------------------------------------------------------|----|
| EM 9050 SPACESAVER | 50 |
| EM 9050 - TILT-UP - HAND SPIN | 51 |
| EM 9050 - SLIDE - MOTORIZED SPIN | 52 |
| EM 9050 - WORKBENCH - HAND SPIN | 53 |
| EM 9050 - WORKBENCH - MOTORIZED SPIN | 53 |

| | |
|---------------------------------------------------------------------|----|
| REKOMENDOWANE AKCESORIA DLA MOBILNYCH SERWISÓW SAMOCHODOWYCH | 54 |
|---------------------------------------------------------------------|----|

WYWAŻARKI DO SAMOCHODÓW OSOBOWYCH/VAN/BUS

EYE-LIGHT PLUS DIAGNOSTICLINE



STANDARDOWE AKCESORIA

Kod 8-21100221



Kod
802227308



Kod
8-21100142

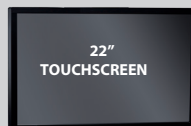

Kod 5-120500A

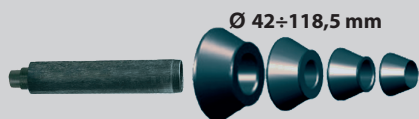

x3



dla wersji Winut



Wersja Winut



| Kod | Zasilanie | Opis | Cena netto |
|---------------|--------------------------------------|------------------------------------------------------------------------------------------------------------------------------------------------------------------------------------------------------------------------------------------------------------------------------------------------------------------------------------------------------------------------------------------------------------------------------------------------------------------------------------------------------------------------------------------------------------------------------------------------------------------------------------------------------------------------------------------------------------------------------------------------------------------------------------------------------------------------------------------------------------------------------------------|------------|
| 0-21101100/16 | 100-230V / 1P _H / 50-60Hz | <p>Eye-Light Plus DiagnosticLine Diagnostyczna wyważarka z dotykowym monitorem LCD, przemysłowym komputerem klasy PC, kamerą, systemem WM, automatyczną osłoną koła, bezkontaktowym systemem pobierania danych za pomocą lasera, systemem iPos - system optymalizacji do najlepszego pozycjonowania kół na pojeździe oraz automatycznym mocowaniem koła, panel na tulejki HPC, zestaw tulejek HPC.</p> <p>Diagnostyka koła, lub obręczy przy pomocy precyzyjnych promieni laserowych:</p> <p>a) precyzyjny pomiar bicia koła we wszystkich płaszczyznach (bicie promieniowe i boczne) oraz kalkulacja optymalnego spasowania felga-opona, rozwiązujący większość problemów wibracji powodowanych ogumieniem,</p> <p>b) ścięcie opony, który powoduje że pojazd jest stale ciągnięty w jedną stronę w czasie jazdy w linii prostej,</p> <p>c) głębokość bieżnika w 3 miejscach</p> | 76 167,00 |
| 0-21101101/16 | 100-230V / 1P _H / 50-60Hz | <p>Eye-Light Plus DiagnosticLine WiNUT Jak wyżej, z automatycznym bezprzewodowym mocowaniem koła (WiNUT), wersja bez pedału.</p> | 78 863,00 |



www.corghi.pl

ODLICZ OD CENY -20 % RABATU

Cennik SAMINWEST ważny od 10.11. 2024 do ukazania się nowej wersji.

WYWAŻARKI DO SAMOCHODÓW OSOBOWYCH/VAN/BUS

EM 9980C PLUS DiagnosticLine



Kod
8-21100221

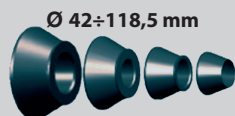

STANDARDOWE AKCESORIA

dla wersji Winut



Kod
802227308

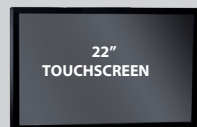

Kod
5-120500A

Kod
8-21100142



32"



Wersja Winut



| Kod | Zasilanie | Opis | Cena netto |
|---------------|--------------------------------------|---------------------------------------------------------------------------------------------------------------------------------------------------------------------------------------------------------------------------------------------------------------------------------------------------------------------------------------------------------------------------------------------------------------------------------------------------------------------------------------------------------------------------------------------------------------------------------|------------|
| 0-21109983/16 | 100-230V / 1P _H / 50-60Hz | EM 9980C PLUS DiagnosticLine Diagnostyczna wyważarka z dotykowym monitorem LCD, systemem WM, bezkontaktowym systemem pobierania danych za pomocą lasera, systemem iPos- system optymalizacji do najlepszego pozycjonowania kół na pojeździe oraz automatycznym mocowaniem koła. Diagnostyka koła, lub obręczy przy pomocy precyzyjnych promieni laserowych: precyzyjny pomiar bicia koła we wszystkich płaszczyznach (bicie promieniowe i boczne) oraz kalkulacja optymalnego spasowania felga-opona, rozwiązujący większość problemów wibracji powodowanych ogumieniem. | 54 833,00 |
| 0-21109984/16 | 100-230V / 1P _H / 50-60Hz | EM 9980C PLUS DiagnosticLine WiNUT Jak wyżej, z automatycznym bezprzewodowym mocowaniem koła (WiNUT), wersja bez pedału. | 57 477,00 |

ODLICZ OD CENY -20% RABATU



www.corghi.pl

WYWAŻARKI DO SAMOCHODÓW OSOBOWYCH/VAN/BUS

EM 9780C PLUS AUTOMATICLINE



STANDARDOWE AKCESORIA

Kod
8-21100221



Ø 42÷118,5 mm

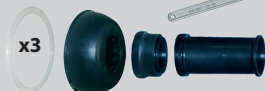

x3



dla wersji Winut



Kod
802227308

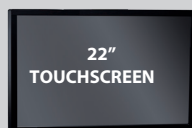

Kod
5-120500A

Kod
8-21100142



32"



| Kod | Zasilanie | Opis | Cena netto |
|---------------|--------------------------------------|-------------------------------------------------------------------------------------------------------------------------------------------------------------------------------------------------------------------------------------------------------------------------------------------------------------------------------------|------------|
| 0-21109783/16 | 100-230V / 1P _H / 50-60Hz | EM 9780C PLUS AutomaticLine Wyważarka z dotykowym monitorem LCD, bezkontaktowym systemem wprowadzania danych koła (połączenie lasera i sonaru AWD (standard)), systemem oszczędzania ciężarków (WM), systemem iPos - system optymalizacji do najlepszego pozycjonowania kół na pojeździe oraz automatycznym mocowaniem koła. | 44 548,00 |
| 0-21109784/16 | 100-230V / 1P _H / 50-60Hz | EM 9780C PLUS AutomaticLine WinUT Jak wyżej, z automatycznym bezprzewodowym mocowaniem koła (WinUT), wersja bez pedału. | 47 192,00 |
| 8-21100250 | - | Sonar diagnostyczny (opcja) precyzyjny pomiar bicia koła we wszystkich płaszczyznach (bicie promieniowe i boczne) oraz kalkulacja optymalnego spasowania felgaopona, rozwiązujący większość problemów wibracji powodowanych ogumieniem | + 2 574,00 |

Polecane

ODLICZ OD CENY -20 % RABATU



www.corghi.pl

WYWAŻARKI DO SAMOCHODÓW OSOBOWYCH/VAN/BUS

EM 9580 C Plus TOUCHSCREEN



STANDARDOWE AKCESORIA

Kod
8-11100221

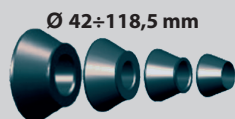

Ø 42÷118,5 mm



x3

Kod 5-120500A

Kod
8-21100159



dla wersji Winut

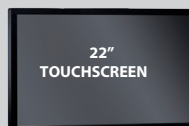

22"
TOUCHSCREEN

Kod
802227308



Kod
8-21100142



28"



| Kod | Zasilanie | Opis | Cena netto |
|---------------|--------------------------------------|-----------------------------------------------------------------------------------------------------------------------------------------------------------------------------------------------------------------------------------------------------------------------------------------------------------------------------------------------------------------------------------------------------------------------------------------------------------------------------------|-------------------|
| 0-21109591/16 | 100-230V / 1P _H / 50-60Hz | EM 9580C PLUS TouchScreen Wyważarka z automatycznym systemem szybkococującym, z 22-calowym monitorem dotykowym, wskaźnikiem LaserLine (2 lasery), oświetleniem LED. Tradycyjne ramię do wprowadzania danych z 28-calowym urządzeniem SmartArm do automatycznego wprowadzania danych z programem szybkiego wyboru FST, funkcją LaserBlade, osłona koła „Zero Space”, program oszczędzania ciężarków WM w zestawie. Zalecamy dokupić opcjonalnie AWD (+ 2 635,00 zł). | 36 396,00 |
| 0-21109592/16 | 100-230V / 1P _H / 50-60Hz | EM 9580C PLUS TouchScreen WINUT Jak wyżej, z automatycznym bezprzewodowym mocowaniem koła (WiNUT), wersja bez pedału. Zalecamy dokupić opcjonalnie AWD (+ 2 635,00 zł). | 39 040,00 |
| 8-21100250 | - | Sonar diagnostyczny (opcja) umożliwiający precyzyjny pomiar bicia promieniowego koła w jednej płaszczyźnie. | + 2 574,00 |

Polecane

ODLICZ OD CENY -20 % RABATU



www.corghi.pl

9

Cennik SAMiNWEST ważny od 10.11.2024 do ukazania się nowej wersji.

Zdjęcie ma charakter poglądowy i może przedstawiać urządzenie z akcesoriami opcjonalnymi.

2028323520

WYWAŻARKI DO SAMOCHODÓW OSOBOWYCH/VAN/BUS

EM 9580 PLUS TOUCHSCREEN



STANDARDOWE AKCESORIA

Kod
8-11100221

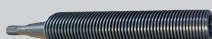

Kod
802227308



Ø 42÷118,5 mm

Kod
8-21100159



Kod
8-21100142



x3

Kod 5-120500A

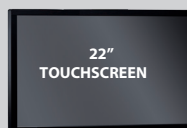

22"
TOUCHSCREEN



28"



| Kod | Zasilanie | Opis | Cena netto |
|---------------|--------------------------------------|------------------------------------------------------------------------------------------------------------------------------------------------------------------------------------------------------------------------------------------------------------------------------------------------------------------------------------------------------------------------------------------------|-------------------|
| 0-21109590/16 | 100-230V / 1P _H / 50-60Hz | EM 9580 PLUS TouchScreen Wyważarka do kół z 22-calowym przemysłowym monitorem dotykowym, wskaźnikiem LaserLine, podświetleniem LED, 28-calowym urządzeniem SmartArm do automatycznego wprowadzania danych z programem FST Fast Selection, funkcją LaserBlade, ręcznym mocowaniem koła, osłoną koła „Zero Space”, programem WM. Zalecamy dokupić opcjonalnie AWD (+ 2 635,00 zł). | 31 150,00 |
| 8-21100250 | - | Sonar diagnostyczny (opcja) umożliwiający precyzyjny pomiar bicia promieniowego koła w jednej płaszczyźnie | + 2 574,00 |

ODLICZ OD CENY -20 % RABATU



www.corgi.pl

WYWAŻARKI DO SAMOCHODÓW OSOBOWYCH/VAN/BUS

EM 9580 C Plus LASERLINE



STANDARDOWE AKCESORIA

Kod
8-11100221



Kod
802227308



Kod
8-21100159



Kod
8-21100142



dla wersji Winut



| Kod | Zasilanie | Opis | Cena netto |
|---------------|--------------------------------------|-------------------------------------------------------------------------------------------------------------------------------------------------------------------------------------------------------------------------------------------------------------------------------------------------------------------------------------------------------|-------------------|
| 0-21109586/16 | 100-230V / 1P _H / 50-60Hz | EM 9580C PLUS LaserLine Wyważarka z automatycznym systemem szybkoocującym zwiększającym komfort pracy, dwoma wskaźnikami laserowymi, automatycznym dobieraniem odpowiedniego programu wyważania, systemem oszczędzania ciężarków (program WM), monitorem LCD, osłona "Zero space". Zalecamy dokupić opcjonalnie AWD (+ 2 635,00 zł). | 32 874,00 |
| 0-21109588/16 | 100-230V / 1P _H / 50-60Hz | EM 9580C Plus LaserLine WINUT Jak wyżej, z automatycznym bezprzewodowym mocowaniem koła (WiNUT), wersja bez pedału. Zalecamy dokupić opcjonalnie AWD (+ 2 635,00 zł). | 35 517,00 |
| 8-21100250 | - | Sonar diagnostyczny (opcja) umożliwiający precyzyjny pomiar bicia promieniowego koła w jednej płaszczyźnie | + 2 574,00 |

Polecane

ODLICZ OD CENY -20 % RABATU



www.corghi.pl

WYWAŻARKI DO SAMOCHODÓW OSOBOWYCH/VAN/BUS

EM 9580 PLUS LASERLINE



STANDARDOWE AKCESORIA

Kod
8-21100221



Ø 42±118,5 mm



Kod
802227308



x3

Kod
8-21100159

Kod
8-21100142



28"



| Kod | Zasilanie | Opis | Cena netto |
|---------------|--------------------------------------|--------------------------------------------------------------------------------------------------------------------------------------------------------------------------------------------------------------------------------------------------------------------------|-------------------|
| 0-21109587/16 | 100-230V / 1P _H / 50-60Hz | EM 9580 PLUS LaserLine Wyważarka do kół ze wskaźnikiem LaserLine, ręczne mocowanie koła, automatyczne wprowadzanie danych z programem szybkiego wyboru, osłona koła „Zero Space”, w zestawie program WM. Zalecamy dokupić opcjonalnie AWD (+ 2 635,00 zł). | 27 680,00 |
| 8-21100250 | - | Sonar diagnostyczny (opcja) umożliwiający precyzyjny pomiar bicia promieniowego koła w jednej płaszczyźnie | + 2 574,00 |

ODLICZ OD CENY -20 % RABATU



www.corgi.pl

WYWAŻARKI DO SAMOCHODÓW OSOBOWYCH/VAN/BUS

EM 9550 C Plus LASERLINE



Kod
8-21100221

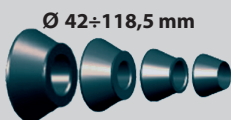

Kod
802227308



Kod
8-21100159

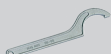

| Kod | Zasilanie | Opis | Cena netto |
|---------------|--------------------------------------|-----------------------------------------------------------------------------------------------------------------------------------------------------------------------------------------------------------------------------------------------------------------------------------------------|------------------|
| 0-21109556/16 | 100-230V / 1P _H / 50-60Hz | EM 9550 C Plus LaserLine Wyważarka z elektromechanicznym uchwytem szybkoocującym za pomocą pedału, wyświetlaczem, wskaźnikiem laserowym oraz automatycznym dobieraniem odpowiedniego programu wyważania, osłona "Zero space". Zalecamy dokupić opcjonalnie AWD (+ 2 635,00 zł). | 27 259,00 |

ODLICZ OD CENY -20% RABATU



www.corgi.pl

WYWAŻARKI DO SAMOCHODÓW OSOBOWYCH/VAN/BUS

EM 9550 PLUS LASERLINE



Kod
8-21100221



Kod
802227308



Kod
8-21100159



STANDARDOWE AKCESORIA



| Kod | Zasilanie | Opis | Cena netto |
|---------------|--------------------------------------|---------------------------------------------------------------------------------------------------------------------------------------------------------------------------------------------------------------------------|------------------|
| 0-21109557/16 | 100-230V / 1P _H / 50-60Hz | EM 9550 Plus LaserLine Wyważarka z wyświetlaczem, wskaźnikiem laserowym, automatycznym dobieraniem odpowiedniego programu wyważania, osłona "Zero space". Zalecamy dokupić opcjonalnie AWD (+ 2 635,00 zł). | 22 178,00 |

ODLICZ OD CENY -20 % RABATU



www.corghi.pl

WYWAŻARKI DO SAMOCHODÓW OSOBOWYCH/VAN/BUS

EM 9380 C XLINE TOUCHSCREEN

EM 9380 C XLINE



STANDARDOWE AKCESORIA

Kod
8-21100221

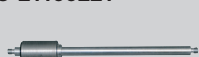

Kod
802227308

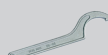

28"



| Kod | Zasilanie | Opis | Cena netto |
|---------------|--------------------------|-------------------------------------------------------------------------------------------------------------------------------------------------------------------------------------------------------------------------------------------------------------------------------------------------------------------------|------------|
| 0-21193806/16 | 200-230V / 1Ph / 50-60Hz | EM9380C XLine TOUCHSCREEN Wyważarka z dotykowym ekranem, z elektromechanicznym uchwytem szybkoocującym za pomocą pedału, wskaźnikiem laserowym, automatycznym wprowadzaniem danych oraz systemem oszczędzania ciężarków (program WM). Zalecamy dokupić opcjonalnie AWD (+ 2 635,00 zł) i KLIP (+ 222,00). | 31 714,00 |
| 0-21193802/16 | 200-230V / 1Ph / 50-60Hz | EM9380C XLine Wyważarka z monitorem LCD, z elektromechanicznym uchwytem szybkoocującym za pomocą pedału, wskaźnikiem laserowym, automatycznym wprowadzaniem danych oraz systemem oszczędzania ciężarków (program WM). Zalecamy dokupić opcjonalnie AWD (+ 2 635,00 zł) i KLIP (+ 222,00). | 28 244,00 |

ODLICZ OD CENY -20% RABATU



www.corgi.pl

WYWAŻARKI DO SAMOCHODÓW OSOBOWYCH/VAN/BUS

EM 9380 XLINE TOUCHSCREEN EM 9380 XLINE



Kod
8-21100221

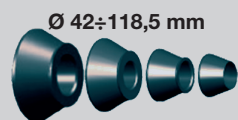

Kod
802227308



STANDARDOWE AKCESORIA

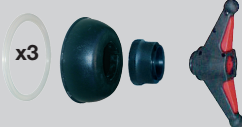

| Kod | Zasilanie | Opis | Cena netto |
|---------------|--------------------------|----------------------------------------------------------------------------------------------------------------------------------------------------------------------------------------------------------------------------------------------------|------------|
| 0-21193805/16 | 200-230V / 1Ph / 50-60Hz | EM9380 XLine TOUCHSCREEN Wyważarka z monitorem LCD, automatycznym wprowadzaniem danych, wskaźnikiem laserowym oraz systemem oszczędzania ciężarków (program WM). Zalecamy dokupić opcjonalnie AWD (+ 2 635,00 zł) i KLIP (+ 222,00). | 26 596,00 |
| 0-21193800/16 | 200-230V / 1Ph / 50-60Hz | EM9380 XLine Wyważarka z monitorem LCD, automatycznym wprowadzaniem danych, wskaźnikiem laserowym oraz systemem oszczędzania ciężarków (program WM). Zalecamy dokupić opcjonalnie AWD (+ 2 635,00 zł) i KLIP (+ 222,00). | 23 126,00 |

ODLICZ OD CENY -20% RABATU



www.corgi.pl

WYWAŻARKI DO SAMOCHODÓW OSOBOWYCH/VAN/BUS

EM 9350 C XLINE



Kod
8-21100221

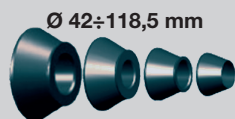
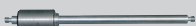

Kod
802227308

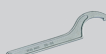

STANDARDOWE AKCESORIA



| Kod | Zasilanie | Opis | Cena netto |
|---------------|--------------------------|----------------------------------------------------------------------------------------------------------------------------------------------------------------------------------------------------------------------------------------------------------|------------------|
| 0-21193502/16 | 200-230V / 1Ph / 50-60Hz | EM9350C XLine Wyważarka z wyświetlaczem, wskaźnikiem laserowym, z elektromechanicznym uchwytem szybkołączącym za pomocą pedału, automatycznym wprowadzaniem danych. Zalecamy dokupić opcjonalnie AWD (+ 2 635,00 zł) i KLIP (+ 222,00). | 23 086,00 |

ODLICZ OD CENY -20% RABATU



www.corghi.pl

WYWAŻARKI DO SAMOCHODÓW OSOBOWYCH/VAN/BUS

EM 9350 XLINE



STANDARDOWE AKCESORIA

Kod
8-21100221



Kod
802227308



28"



| Kod | Zasilanie | Opis | Cena netto |
|---------------|--------------------------------------|-----------------------------------------------------------------------------------------------------------------------------------------------------------------------------------------|------------------|
| 0-21193500/16 | 200-230V / 1P _H / 50-60Hz | EM9350 XLine Wyważarka z wyświetlaczem, wskaźnikiem laserowym, automatycznym wprowadzaniem danych. Zalecamy dokupić opcjonalnie AWD (+ 2 635,00 zł) i KLIP (+ 222,00). | 17 878,00 |

ODLICZ OD CENY -20 % RABATU



www.corghi.pl

EM 9280 C COMPACTLINE

STANDARDOWE AKCESORIA

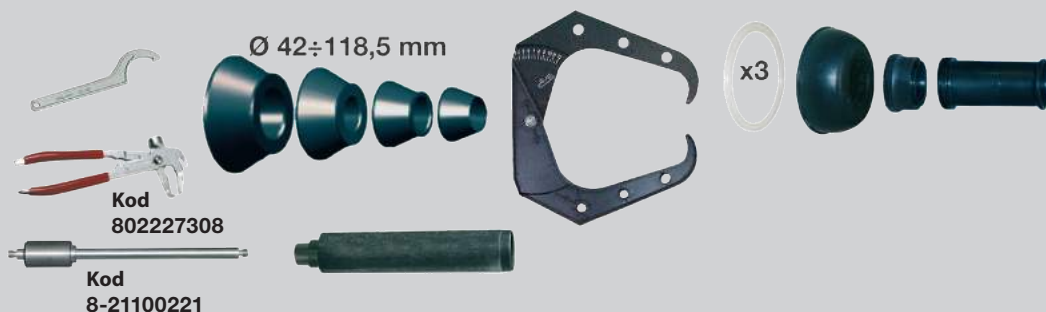

| Kod | Zasilanie | Opis | Cena netto |
|---------------|--------------------------------------|--------------------------------------------------------------------------------------------------------------------------------------------------------------------------------------------------------------------------------------------------------------------------------------------------------------------------------------------------------------------------|------------------|
| 0-21192804/16 | 200-230V / 1P _H / 50-60Hz | EM9280C CompactLine Wyważarka z monitorem LCD, pneumatycznym uchwytem szybkoocucującym, automatycznym wprowadzeniem danych, z automatycznym zatrzymaniem na koniec wyrzutu, z systemem RPA, z systemem oszczędzania ciężarków (Program WM). Zalecamy dokupić opcjonalnie AWD (+ 2 635,00 zł), LASER (+ 1 413,00), KLIP (+ 222,00) oraz PL50 (+ 359,00). | 24 998,00 |

Polecane

ODLICZ OD CENY -20% RABATU

EM 9280 COMPACTLINE



Kod
8-21100221

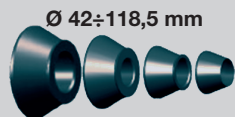

Kod
802227308



STANDARDOWE AKCESORIA

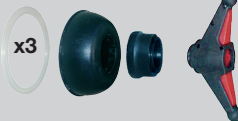

28''



| Kod | Zasilanie | Opis | Cena netto |
|---------------|--------------------------|-----------------------------------------------------------------------------------------------------------------------------------------------------------------------------------------------------------------------------------------------------------------------------------------------------------------------------|------------|
| 0-21192800/16 | 200-230V / 1Ph / 50-60Hz | EM9280 CompactLine Wyważarka z monitorem LCD, automatycznym wprowadzeniem danych, z automatycznym zatrzymaniem na koniec wyrzutu, z systemem RPA, z systemem oszczędzania ciężarków (Program WM). Zalecamy dokupić opcjonalnie AWD (+ 2 635,00 zł), LASER (+ 1 413,00), KLIP (+ 222,00) oraz PL50 (+ 359,00). | 20 082,00 |

ODLICZ OD CENY -20 % RABATU

WYWAŻARKI DO SAMOCHODÓW OSOBOWYCH/VAN/BUS

EM 9250 COMPACTLINE



STANDARDOWE AKCESORIA

Kod
8-21100221



Ø 42÷118,5 mm

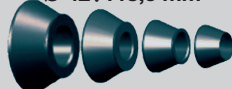

x3
Kod
802227308



28''

Wersja premium



| Kod | Zasilanie | Opis | Cena netto |
|---------------|--------------------------------------|---------------------------------------------------------------------------------------------------------------------------------------------------------------------------------------------------------------------------------------------------------------------------------------------------|------------|
| 0-21192508/16 | 200-230V / 1P _H / 50-60Hz | EM 9250 CompactLine Wersja PREMIUM: Wyświetlacz, automatyczne wprowadzenie danych oraz automatyczne zatrzymanie na koniec wyrzutu. Elektryczny hamulec oraz system RPA. Zalecamy dokupić opcjonalnie AWD (+ 2 635,00 zł), LASER (+ 1 413,00), KLIP (+ 222,00) oraz PL50 (+ 359,00). | 14 181,00 |
| 0-21192504/16 | 200-230V / 1P _H / 50-60Hz | EM 9250 CompactLine Wersja PROFESSIONAL: maszyna z wyświetlaczem LCD z automatycznym wprowadzaniem danych i automatycznym hamulcem na końcu wirowania. Zalecamy dokupić opcjonalnie LASER (+ 1 413,00), KLIP (+ 222,00) oraz PL50 (+ 359,00). | 13 305,00 |
| 0-21192500/16 | 200-230V / 1P _H / 50-60Hz | EM 9250 CompactLine Wersja BASIC: maszyna z wyświetlaczem LCD z ręcznym wprowadzaniem danych i automatycznym hamulcem na końcu wirowania. Zalecamy dokupić opcjonalnie LASER (+ 1 413,00), KLIP (+ 222,00) oraz PL50 (+ 359,00). | 11 546,00 |

ODLICZ OD CENY -20% RABATU



www.corghi.pl

WYWAŻARKI DO MOTOCYKLI

EM 9250 BASIC BIKELINE



28"



| Kod | Zasilanie | Opis | Cena netto |
|---------------|--------------------------|-------------------------------------------------------------------------------------------------------------------------------------------------------------------------|------------------|
| 0-21192512/16 | 200-230V / 1PH / 50-60Hz | EM 9250 Wyważarka do kół motocyklowych z ręcznym wprowadzeniem danych i ręcznym mocowaniem kół, zawiera wyświetlacz LCD. W zestawie z BIKE UNIVERSAL KIT i PRA4. | 14 820,00 |

ODLICZ OD CENY -20 % RABATU





www.corghi.pl

AKCESORIA DO WYWAŻAREK SAMOCHODOWYCH I MOTOCYKLOWYCH

| | Opis | Kod | Cena netto | EYE-LIGHT PLUS | EM9980 C PLUS | EM9780 C PLUS | EM9580 C Plus TOUCHSCR | EM9580 Plus TOUCHSCREEN | EM9580 C Plus | EM9580 Plus | EM9550 C Plus | EM9550 Plus | EM9380 C / TOUCHSCREEN | EM9380 / TOUCHSCREEN | EM9350 C | EM9350 | EM9280 C | EM9280 | EM9250 C PREMIUM | EM9250 PREMIUM | EM9250 PROFESSIONAL | EM9250 BASIC | EM9250 BASIC BIKELINE | |
|-----------------------------------------------------------------------------------|---------------------------------|------------|------------|----------------|---------------|---------------|------------------------|-------------------------|---------------|-------------|---------------|-------------|------------------------|----------------------|----------|--------|----------|--------|------------------|----------------|---------------------|--------------|-----------------------|---|
| | | | | | | | | | | | | | | | | | | | | | | | | |
| MONITORY | | | | | | | | | | | | | | | | | | | | | | | | |
|  | Monitor 22" | 8-21100234 | 1 407,00 | - | - | - | - | - | O | O | - | - | O | O | - | - | - | - | - | - | - | - | - | - |
|  | Zestaw do czyszczenia monitorów | 8-21120006 | 114,00 | O | O | O | O | O | O | O | - | - | O | O | - | - | O | O | - | - | - | - | - | - |



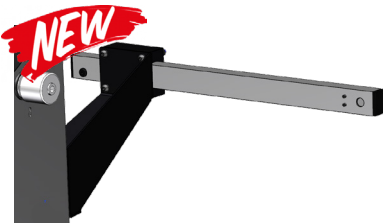

■ = Standard O = Kompatybilne - = NIEkompatybilne

AKCESORIA DO WYWAŻAREK SAMOCHODOWYCH I MOTOCYKLOWYCH

| | Opis | Kod | Cena netto | EYE-LIGHT PLUS | EM9380 C PLUS | EM9780 C PLUS | EM9580 C Plus TouchScr | EM9580 Plus TouchSCREEN | EM9580 C Plus | EM9580 Plus | EM9550 C Plus | EM9550 Plus | EM9380 C / TouchSCREEN | EM9380 / TouchSCREEN | EM9350 C | EM9350 | EM9280 C | EM9280 | EM9250 C PREMIUM | EM9250 PREMIUM | EM9250 PROFESSIONAL | EM9250 BASIC | EM9250 Basic BikeLine | |
|---------------------------------------------------------------------------------------------------------|-------------------------------------------------------------------------------------------------------------------------------------------------------------------------------------------------------------------------------------|------------|------------|----------------|---------------|---------------|------------------------|-------------------------|---------------|-------------|---------------|-------------|------------------------|----------------------|----------|--------|----------|--------|------------------|----------------|---------------------|--------------|-----------------------|---|
| | | | | | | | | | | | | | | | | | | | | | | | | |
| URZĄDZENIA ELEKTRONICZNE | | | | | | | | | | | | | | | | | | | | | | | | |
|  LAN CONNECTION KIT | ZESTAW DO PODŁĄCZENIA SIECI LAN Zestaw do podłączenia wyważarki do sieci systemu zarządzania firmą; pozwala przeglądać, archiwizować i drukować zdalnie różne raporty pomiarowe i diagnostyczne wyważarki diagnostycznej. | 8-21100255 | 1 154,00 | O | O | O | O | C | O | O | - | - | O | O | - | - | O | O | - | - | - | - | - | - |
|  | Zestaw RRS-2, zestaw sonaru | 8-21100277 | 1 986,00 | - | - | - | - | - | - | - | - | - | O | O | - | - | O | O | - | - | - | - | - | - |
|  | EG1 Pomiar szerokości koła. | 8-21100074 | 2 433,00 | - | - | - | - | - | - | - | - | - | - | - | - | - | - | - | - | - | O | - | - | |
|  | WYKRYWANIE ROZMIARÓW KOŁA cyfrowy miernik do pozyskiwania średnicy i odległości. Maksymalna precyzja przy wykorzystaniu systemu FSP, który automatycznie dobiera odpowiedni program wyważania. | 8-21120022 | 975,00 | - | - | - | - | - | - | - | - | - | O | O | O | O | O | O | O | O | O | O | O | |

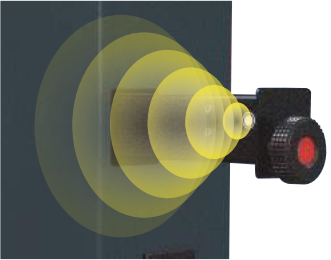

■ = Standard O = Kompatybilne - = NIEkompatybilne

AKCESORIA DO WYWAŻAREK SAMOCHODOWYCH I MOTOCYKLOWYCH

| | Opis | Kod | Cena netto | EYE-LIGHT PLUS | EM9980 C PLUS | EM9780 C PLUS | EM9580 C Plus TOUCHSCR | EM9580 Plus TOUCHSCREEN | EM9580 C Plus | EM9580 Plus | EM9550 C Plus | EM9550 Plus | EM9380 C / TOUCHSCREEN | EM9380 / TOUCHSCREEN | EM9350 C | EM9350 | EM9280 C | EM9280 | EM9250 C PREMIUM | EM9250 PREMIUM | EM9250 PROFESSIONAL | EM9250 BASIC | EM9250 Basic BikeLINE | |
|-------------------------------------------------------------------------------------|-------------------------------------------------------------------------------------------------------------------------------------------------------------------------------------------------------------|------------|------------|----------------|---------------|---------------|------------------------|-------------------------|---------------|-------------|---------------|-------------|------------------------|----------------------|----------|--------|----------|--------|------------------|----------------|---------------------|--------------|-----------------------|---|
| | | | | | | | | | | | | | | | | | | | | | | | | |
|  | WYKRYWANIE ROZMIARÓW KOŁA cyfrowy miernik do pozyskiwania średnicy i odległości. Maksymalna precyzja przy wykorzystaniu systemu FSP, który automatycznie dobiera odpowiedni program wyważania. | 8-21120023 | 975,00 | - | - | - | ■ | ■ | ■ | ■ | ■ | ■ | - | - | - | - | - | - | - | - | - | - | - | - |
|  | Laser & Led Zestaw wskaźnika laserowego i światło LED | 8-21100238 | 1 413,00 | - | - | - | - | - | - | - | - | - | - | - | - | - | ○ | ○ | ○ | ○ | ○ | ○ | ○ | - |
|  | AWD Zestaw do ultradźwiękowego pomiaru szerokości koła Sonar Sensor. | 8-21100232 | 2 635,00 | - | - | ■ | ○ | ○ | ○ | ○ | ○ | ○ | ○ | ○ | ○ | ○ | ○ | ○ | ○ | ○ | - | - | - | - |
|  | ZESTAW DO MONTAŻU - WINUT do dodania systemu WiNut do wyważarek wyprodukowanych bez niego; EM92xx-C i EM93xx-C produkowane od lipca 2019 r | 8-21100242 | 2 993,00 | ○ | ○ | ○ | ○ | - | ○ | - | - | - | ○ | - | ○ | - | ○ | - | ○ | - | - | - | - | - |
|  | Zestaw Sonar RUNOUT z nowymi funkcjami BESTFIT | 8-21100250 | 2 574,00 | - | - | ○ | ○ | ○ | ○ | ○ | - | - | - | - | - | - | - | - | - | - | - | - | - | - |





■ = Standard ○ = Kompatybilne - = NIEkompatybilne

AKCESORIA DO WYWAŻAREK SAMOCHODOWYCH I MOTOCYKLOWYCH

| | Opis | Kod | Cena netto | EYE-LIGHT PLUS | EM9980 C PLUS | EM9780 C PLUS | EM9580 C Plus TouchScr | EM9580 Plus TouchSCREEN | EM9580 C Plus | EM9580 Plus | EM9550 C Plus | EM9550 Plus | EM9380 C / TOUCHSCREEN | EM9380 / TOUCHSCREEN | EM9350 C | EM9350 | EM9280 C | EM9280 | EM9250 C PREMIUM | EM9250 PREMIUM | EM9250 PROFESSIONAL | EM9250 BASIC | EM9250 BASIC BIKELINE |
|-------------------------------------------------------------------------------------|--------------------------------------------------------------------------------------------------------|------------|------------|----------------|---------------|---------------|------------------------|-------------------------|---------------|-------------|---------------|-------------|------------------------|----------------------|----------|--------|----------|--------|------------------|----------------|---------------------|--------------|-----------------------|
| | | | | | | | | | | | | | | | | | | | | | | | |
| PODNOŚNIKI | | | | | | | | | | | | | | | | | | | | | | | |
|  | TT-0 Automatyczny samopoziomujący podnośnik koła. Zasilanie pneumatyczne. Udźwig 80kg. | 8-21100230 | 9 617,00 | O | O | O | O | O | O | O | O | O | O | O | O | O | O | O | O | O | O | O | O |
|  | TT-R Profesjonalny regulowany podnośnik nożycowy, sterowanie jedną ręką, udźwig 80 kg | 8-21100248 | 6 677,00 | O | O | O | O | O | O | O | O | O | O | O | O | O | O | O | O | O | O | O | O |
|  | Zestaw montażowy do podnośnika TT-ZERO GRAVITY i TT-R , tylko do EM9380, EM9350, EM9280 i 9250. | 8-21100231 | 194,00 | - | - | - | - | - | - | - | - | - | O | O | O | O | O | O | O | O | O | O | O |

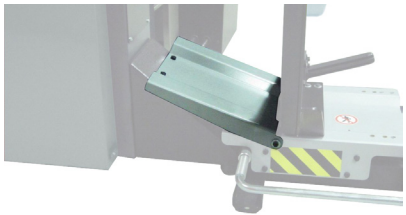

■ = Standard O = Kompatybilne - = NIEkompatybilne

AKCESORIA DO WYWAŻAREK SAMOCHODOWYCH I MOTOCYKLOWYCH

| | Opis | Kod | Cena netto | EYE-LIGHT PLUS | EM9980 C PLUS | EM9780 C PLUS | EM9580 C Plus TOUCHSCR | EM9580 Plus TOUCHSCREEN | EM9580 C PLUS | EM9580 Plus | EM9550 C PLUS | EM9550 Plus | EM9380 C / TOUCHSCREEN | EM9380 / TOUCHSCREEN | EM9350 C | EM9350 | EM9280 C | EM9280 | EM9250 C PREMIUM | EM9250 PREMIUM | EM9250 PROFESSIONAL | EM9250 BASIC | EM9250 BASIC BIKELINE |
|-------------------------------------------------------------------------------------|-------------------------------------------------------------------------------------------------------------------------------------------|------------|------------|----------------|---------------|---------------|------------------------|-------------------------|---------------|-------------|---------------|-------------|------------------------|----------------------|----------|--------|----------|--------|------------------|----------------|---------------------|--------------|-----------------------|
|  | Zestaw klap do podnośnika TT-ZERO GRAVITY i TT-R (umożliwia montaż podnośnika na wyważarce ze stopką boczną) do EM9280, EM9250. | 8-21600132 | 556,00 | - | - | - | - | - | - | - | - | - | - | - | - | - | 0 | 0 | 0 | 0 | 0 | 0 | 0 |
|  | TT 80 Uniwersalny podnośnik pneumatyczny, maks. obciążenie kg 80. | 8-21100161 | 4 691,00 | 0 | 0 | 0 | 0 | 0 | 0 | 0 | 0 | 0 | 0 | 0 | 0 | 0 | 0 | 0 | 0 | 0 | 0 | 0 | 0 |
|  | FTT1 Zestaw montażowy do TT80. | 8-21100163 | 194,00 | - | - | - | - | - | - | - | - | - | 0 | 0 | 0 | 0 | 0 | 0 | 0 | 0 | 0 | 0 | 0 |
|  | FTT2 Zestaw montażowy do TT80. | 8-21120002 | 194,00 | 0 | 0 | 0 | 0 | 0 | 0 | 0 | 0 | 0 | - | - | - | - | - | - | - | - | - | - | - |

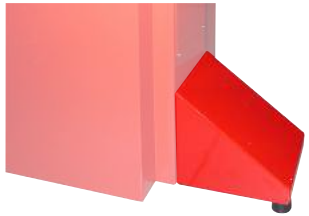

■ = Standard 0 = Kompatybilne - = NIEkompatybilne

AKCESORIA DO WYWAŻAREK SAMOCHODOWYCH I MOTOCYKLOWYCH

| | Opis | Kod | Cena netto | EYE-LIGHT PLUS | EM9980 C PLUS | EM9780 C PLUS | EM9580 C Plus TouchScr | EM9580 Plus TouchSCREEN | EM9580 C Plus | EM9580 Plus | EM9550 C Plus | EM9550 Plus | EM9380 C / TOUCHSCREEN | EM9380 / TOUCHSCREEN | EM9350 C | EM9350 | EM9280 C | EM9280 | EM9250 C PREMIUM | EM9250 PREMIUM | EM9250 PROFESSIONAL | EM9250 BASIC | EM9250 BASIC BIKELINE | |
|-------------------------------------------------------------------------------------|-------------------------------------------------------------------------------------------------------------------------------------------------------------------------------------------------------------------|---------------|------------|----------------|---------------|---------------|------------------------|-------------------------|---------------|-------------|---------------|-------------|------------------------|----------------------|----------|--------|----------|--------|------------------|----------------|---------------------|--------------|-----------------------|---|
| | | | | | | | | | | | | | | | | | | | | | | | | |
| ZESTAWY MODERNIZACYJNE | | | | | | | | | | | | | | | | | | | | | | | | |
|  | Boczny panel podtrzymujący : panel podtrzymujący uchwyt na akcesoria do zestawów centrujących i zestawów HPC, malowany na kolor czerwony (dla wyważarek pomalowanych już na kolor czerwony RAL 3002 - /16) | 8-21100258/16 | 467,00 | - | - | - | - | - | - | - | - | - | - | - | - | - | 0 | 0 | 0 | 0 | 0 | 0 | 0 | 0 |
| | Boczny panel podtrzymujący : panel podtrzymujący uchwyt na akcesoria do zestawów centrujących i zestawów HPC, malowany na kolor czerwony (dla wyważarek niepomalowanych na kolor czerwony RAL 3002 - /16) | 8-21100258/90 | 467,00 | - | - | - | - | - | - | - | - | - | - | - | - | - | 0 | 0 | 0 | 0 | 0 | 0 | 0 | 0 |
|  | Panel nośny do zestawu centrującego HPC High Precision Collets, lakierowany na kolor czerwony (do wyważarek lakierowanych już na kolor czerwony RAL 3002 w /16) | 8-21100253/16 | 933,00 | - | 0 | 0 | 0 | 0 | 0 | 0 | 0 | 0 | - | - | - | - | - | - | - | - | - | - | - | - |
| | Panel nośny do zestawu centrującego HPC High Precision Collets, lakierowany na kolor czerwony (do wyważarek niepomalowanych na kolor czerwony RAL 3002 w /16) | 8-21100253/90 | 933,00 | ■ | 0 | 0 | 0 | 0 | 0 | 0 | 0 | 0 | - | - | - | - | - | - | - | - | - | - | - | - |
|  | PL50 Stopka do montażu bez kotwienia do podłoża. Maksymalny ciężar koła jest ograniczony do 50 kg z zamontowaną stopą (CZERWONA) | 8-21100158/16 | 359,00 | - | - | - | - | - | - | - | - | - | - | - | - | - | 0 | 0 | 0 | 0 | 0 | 0 | 0 | 0 |
| | PL50 Stopka do montażu bez kotwienia do podłoża. Maksymalny ciężar koła jest ograniczony do 50 kg z zamontowaną stopą (CZARNA) | 8-21100158/90 | 359,00 | - | - | - | - | - | - | - | - | - | - | - | - | - | 0 | 0 | 0 | 0 | 0 | 0 | 0 | 0 |





■ = Standard 0 = Kompatybilne - = NIEkompatybilne

AKCESORIA DO WYWAŻAREK SAMOCHODOWYCH I MOTOCYKLOWYCH

| | Opis | Kod | Cena netto | EYE-LIGHT PLUS | EM9980 C PLUS | EM9780 C PLUS | EM9580 C Plus TOUCHScr | EM9580 Plus TOUCHSCREEN | EM9580 C Plus | EM9580 Plus | EM9550 C Plus | EM9550 Plus | EM9380 C / TOUCHSCREEN | EM9380 / TOUCHSCREEN | EM9350 C | EM9350 | EM9280 C | EM9280 | EM9250 C PREMIUM | EM9250 PREMIUM | EM9250 PROFESSIONAL | EM9250 BASIC | EM9250 BASIC BIKELINE | |
|-----------------------------------------------------------------------------------|-----------------------------------------------------------------------------------------------------------------------------------------|---------------|------------|----------------|---------------|---------------|------------------------|-------------------------|---------------|-------------|---------------|-------------|------------------------|----------------------|----------|--------|----------|--------|------------------|----------------|---------------------|--------------|-----------------------|---|
|  | Zestaw kolorów do personalizacji tylko dla EM9250 i EM9280 | 8-21100245/xx | 368,00 | - | - | - | - | - | - | - | - | - | - | - | - | - | 0 | 0 | 0 | 0 | 0 | 0 | 0 | 0 |
|  | Zestaw ASF - Regulowana stopka stabilizująca, optymalizuje stabilność wyważarki kół w przypadku przypadkowego kontaktu operatora | 8-21100299 | 83,00 | 0 | 0 | 0 | 0 | 0 | 0 | 0 | 0 | 0 | 0 | 0 | 0 | 0 | 0 | 0 | 0 | 0 | 0 | 0 | 0 | 0 |





■ = Standard 0 = Kompatybilne - = NIEkompatybilne

AKCESORIA DO WYWAŻAREK SAMOCHODOWYCH I MOTOCYKLOWYCH

| | Opis | Kod | Cena netto | EYE-LIGHT PLUS | EM9980 C PLUS | EM9780 C PLUS | EM9580 C Plus TouchScr | EM9580 Plus TouchSCREEN | EM9580 C Plus | EM9580 Plus | EM9550 C Plus | EM9550 Plus | EM9380 C / TouchSCREEN | EM9380 / TouchSCREEN | EM9350 C | EM9350 | EM9280 C | EM9280 | EM9250 C PREMIUM | EM9250 PREMIUM | EM9250 PROFESSIONAL | EM9250 BASIC | EM9250 BASIC BIKELINE | |
|-------------------------------------------------------------------------------------|---------------------------------------------------------------------------|----------------------|-----------------|----------------|---------------|---------------|------------------------|-------------------------|---------------|-------------|---------------|-------------|------------------------|----------------------|----------|--------|----------|--------|------------------|----------------|---------------------|--------------|-----------------------|---|
| | | | | | | | | | | | | | | | | | | | | | | | | |
| RÓŻNE | | | | | | | | | | | | | | | | | | | | | | | | |
|  | ZESTAW DOZOWNIKA : łatwy w użyciu zestaw dozujący do odważników. | 8-21100251 | 401,00 | O | O | O | O | O | O | O | O | O | O | O | O | O | O | O | O | O | O | O | O | O |
| | Samoprzylepna rolka odważników: metalowa szpula 5 gr x 1200 - 6 kg | 8-21100252 | 208,00 | O | O | O | O | O | O | O | O | O | O | O | O | O | O | O | O | O | O | O | O | O |
|  | Kompletny zestaw osłon kół do serii EM92xx | 8-21100246/90 | 1 413,00 | - | - | - | - | - | - | - | - | - | - | - | - | - | O | O | O | O | O | O | O | O |
|  | Hamulec zaciskowy pedału CB tylko dla EM9250. | 8-21100191 | 655,00 | - | - | - | - | - | - | - | - | - | - | - | - | - | - | - | - | - | O | O | O | O |
|  | AWR urządzenie do usuwania ciężarków. | 802461006 | 95,00 | O | O | O | O | O | O | O | O | O | O | O | O | O | O | O | O | O | O | O | O | O |

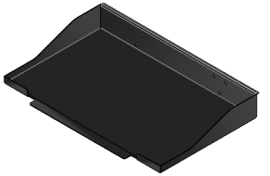
■ = Standard O = Kompatybilne - = NIEkompatybilne

AKCESORIA DO WYWAŻAREK SAMOCHODOWYCH I MOTOCYKLOWYCH

| | Opis | Kod | Cena netto | EYE-LIGHT PLUS | EM9980 C PLUS | EM9780 C PLUS | EM9580 C Plus TOUCHSCR | EM9580 Plus TOUCHSCREEN | EM9580 C PLUS | EM9580 Plus | EM9550 C PLUS | EM9550 Plus | EM9380 C / TOUCHSCREEN | EM9380 / TOUCHSCREEN | EM9350 C | EM9350 | EM9280 C | EM9280 | EM9250 C PREMIUM | EM9250 PREMIUM | EM9250 PROFESSIONAL | EM9250 BASIC | EM9250 BASIC BIKELINE | |
|------------------------------------------------------------------------------------|-------------------------------------------------------------------------------------|----------------------|-----------------|----------------|---------------|---------------|------------------------|-------------------------|---------------|-------------|---------------|-------------|------------------------|----------------------|----------|--------|----------|--------|------------------|----------------|---------------------|--------------|-----------------------|---|
| | | | | | | | | | | | | | | | | | | | | | | | | |
|  | PR Inkjet drukarka USB. | 8-21120005 | 711,00 | O | O | O | O | O | - | - | - | - | - | - | - | - | - | - | - | - | - | - | - | - |
|  | PRS podstawka na drukarkę. | 8-21100236/90 | 443,00 | O | O | O | O | O | - | - | - | - | - | - | - | - | - | - | - | - | - | - | - | - |
|  | PFC szczypce do ciężarków. | 802227308 | 240,00 | ■ | ■ | ■ | ■ | ■ | ■ | ■ | ■ | ■ | ■ | ■ | ■ | ■ | ■ | ■ | ■ | ■ | ■ | ■ | ■ | ■ |
|  | Klip do wspomagania nakładania ciężarków samoprzylepnych dla EM92XX, EM93XX. | 8-21100159 | 222,00 | - | - | - | ■ | ■ | ■ | ■ | ■ | ■ | O | O | O | O | O | O | O | O | O | O | O | O |
|  | PPT zacisk docisku stopy. | 8-21100225 | 1 535,00 | O | O | O | O | O | O | O | O | O | O | O | O | O | O | O | O | O | O | O | O | O |

■ = Standard O = Kompatybilne - = NIEkompatybilne



AKCESORIA DO WYWAŻAREK SAMOCHODOWYCH I MOTOCYKLOWYCH

| | Opis | Kod | Cena Netto | EYE-LIGHT PLUS | EM9980 C PLUS | EM9780 C PLUS | EM9580 C Plus TouchScr | EM9580 Plus TOUCHSCREEN | EM9580 C Plus | EM9580 Plus | EM9550 C Plus | EM9550 Plus | EM9380 C / TOUCHSCREEN | EM9380 / TOUCHSCREEN | EM9350 C | EM9350 | EM9280 C | EM9280 | EM9250 C PREMIUM | EM9250 PREMIUM | EM9250 PROFESSIONAL | EM9250 BASIC | EM9250 BASIC BIKELINE | |
|-----------------------------------|------------------------------------------------------------------------------------------------------------|-------------------|---------------|----------------|---------------|---------------|------------------------|-------------------------|---------------|-------------|---------------|-------------|------------------------|----------------------|----------|--------|----------|--------|------------------|----------------|---------------------|--------------|-----------------------|---|
| | | | | | | | | | | | | | | | | | | | | | | | | |
| ZESTAWY DO CENTROWANIA KÓŁ | | | | | | | | | | | | | | | | | | | | | | | | |
| | GBP40 EVO KIT – profesjonalny zestaw szybkich nakrętek $\varnothing 40 \times 3 \text{mm}$ | 8-21100289 | 632,00 | - | - | - | - | ■ | - | ■ | - | ■ | - | ■ | - | ■ | - | ■ | - | ■ | ■ | ■ | ■ | ○ |
| | PCF1 Ochroniac koła do centrowania felg aluminiowych | 4-115868 | | | | | | | | | | | | | | | | | | | | | | |
| | CF1 Nasadka zacisku koła | 4-115863 | | | | | | | | | | | | | | | | | | | | | | |
| | CD1 Nasadka dystansowa | 4-115864 | | | | | | | | | | | | | | | | | | | | | | |
| | GBP EVO Szybka nakrętkat | 5-101561 | | | | | | | | | | | | | | | | | | | | | | |
| | GBP1 Zacisk „R” | 4-104798 | | | | | | | | | | | | | | | | | | | | | | |
| | GBP2 Zacisk „L” | 4-104799 | | | | | | | | | | | | | | | | | | | | | | |
| | GBP3 Lever | 4-104796 | | | | | | | | | | | | | | | | | | | | | | |
| | CCK3 EVO KIT – zestaw stożków centrujących $\varnothing 40 \text{mm}$ $42 \div 103,5 \text{mm}$ | 8-21100280 | 759,00 | ■ | ■ | ■ | ■ | ■ | ■ | ■ | ■ | ■ | ■ | ■ | ■ | ■ | ■ | ■ | ■ | ■ | ■ | ■ | ■ | ○ |
| | CP1 Mały stożek $\varnothing 42 \div 68 \text{ mm}$ | 5-107970 | | | | | | | | | | | | | | | | | | | | | | |
| | CP2 Średni stożek $\varnothing 60 \div 87 \text{ mm}$ | 5-107968 | | | | | | | | | | | | | | | | | | | | | | |
| | CP3 Duży stożek $\varnothing 83 \div 103 \text{ mm}$ | 5-107969 | | | | | | | | | | | | | | | | | | | | | | |
| | MFL – wał gwintowany XL $\varnothing 40 \times 3 \text{mm}$ - długość: 220mm | 8-21100193 | 834,00 | - | - | - | - | ○ | - | ○ | - | ○ | - | ○ | - | ○ | - | ○ | - | ○ | ○ | ○ | ○ | ○ |
| | MBP40 EVO KIT – Zestaw tulei blokujących do elektrycznego lub pneumatycznego systemu blokowania kół | 8-21100285 | 956,00 | ■ | ■ | ■ | ■ | - | ■ | - | ■ | - | ■ | - | ■ | - | ■ | - | ■ | - | - | - | - | |
| | PCF1 Ochroniac koła do centrowania felg aluminiowych | 4-115868 | | | | | | | | | | | | | | | | | | | | | | |
| | CF1 Nasadka zacisku koła | 4-115863 | | | | | | | | | | | | | | | | | | | | | | |
| | CD1 Nasadka dystansowa | 4-115864 | | | | | | | | | | | | | | | | | | | | | | |
| | QLS Szybkozamykający rękaw | 5-107394 | | | | | | | | | | | | | | | | | | | | | | |

■ = Standard ○ = Kompatybilne - = NIEkompatybilne



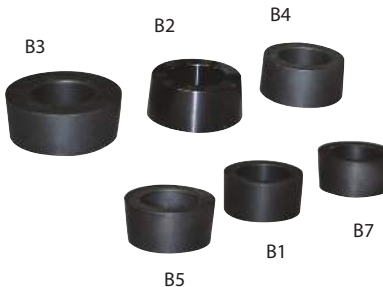



AKCESORIA DO WYWAŻAREK SAMOCHODOWYCH I MOTOCYKLOWYCH

| | Opis | Kod | Cena Netto | EYE-LIGHT PLUS | EM9980 C PLUS | EM9780 C PLUS | EM9680 C Plus TOUCHSCR | EM9580 Plus TOUCHSCREEN | EM9580 C Plus | EM9580 Plus | EM9550 C Plus | EM9550 Plus | EM9380 C / TOUCHSCREEN | EM9380 / TOUCHSCREEN | EM9350 C | EM9350 | EM9280 C | EM9280 | EM9250 C PREMIUM | EM9250 PREMIUM | EM9250 PROFESSIONAL | EM9250 BASIC | EM9250 Basic BikeLine | |
|------------------------------------------------------------------------------------|------------------------------------------------------------------------------------------------------------------------------------------------------------------------------------------|----------------------|-----------------|----------------|---------------|---------------|------------------------|-------------------------|---------------|-------------|---------------|-------------|------------------------|----------------------|----------|--------|----------|--------|------------------|----------------|---------------------|--------------|-----------------------|--|
| | | | | | | | | | | | | | | | | | | | | | | | | |
| ZESTAWY DO CENTROWANIA KÓŁ | | | | | | | | | | | | | | | | | | | | | | | | |
|  | SBC Zestaw 6 tulei do centrowania odwrótej strony Ø 40 mm | 8-21100082 | 1 243,00 | 0 | 0 | 0 | 0 | 0 | 0 | 0 | 0 | 0 | 0 | 0 | 0 | 0 | 0 | 0 | 0 | 0 | 0 | 0 | 0 | |
| | B1 AUDI, BMW, Chrysler, Opel, Rover, Seat, VW, Daewoo, Galaxy (Ford), Lotus, British-Leyland, Smart (Mercedes), Skoda | 4-105075 | | | | | | | | | | | | | | | | | | | | | | |
| | B2 Citroën, Hyundai, Lancia, Maserati, Mazda, Mercedes, Mitsubishi, Nissan, Opel, Peugeot, Saab, Volvo. | 4-105076 | | | | | | | | | | | | | | | | | | | | | | |
| | B3 BMW, Jaguar, Aston Martin. | 4-105077 | | | | | | | | | | | | | | | | | | | | | | |
| | B4 Ford, Honda, Rover | 4-105078 | | | | | | | | | | | | | | | | | | | | | | |
| | B5 Autobianchi, Alfa Romeo, Citroën, Fiat, Lada, Lancia, Jalbot, Biturbo (Maserati), Mazda, Nissan, Peugeot, Porsche, Renault, 2600-3500 serie (Rover), Seat =>90, Skoda, Toyota. | 4-105079 | | | | | | | | | | | | | | | | | | | | | | |
| | B7 Citroën, Daihatsu, Honda, Kia, Mazda, Mitsubishi, Peugeot, Rover, Subaru, Toyota, Agila (Opel), Suzuki, Hyuday. | 4-105080 | | | | | | | | | | | | | | | | | | | | | | |
|  | Zestaw centrujący HPC High Precision Collets (8 dwustronnych, lekko stożkowych tulei) | 8-21100244 | 2 809,00 | ■ | 0 | 0 | 0 | 0 | 0 | 0 | 0 | 0 | 0 | 0 | 0 | 0 | 0 | 0 | 0 | 0 | 0 | 0 | 0 | |
|  | Wózek do zestawu HPC. | 8-21100243/90 | 1 130,00 | 0 | 0 | 0 | 0 | 0 | 0 | 0 | 0 | 0 | 0 | 0 | 0 | 0 | 0 | 0 | 0 | 0 | 0 | 0 | 0 | |



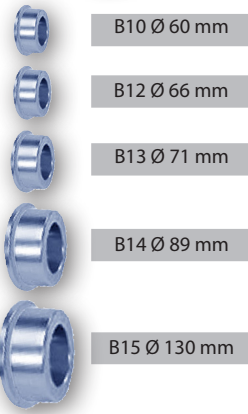

■ = Standard 0 = Kompatybilne - = NIEkompatybilne

AKCESORIA DO WYWAŻAREK SAMOCHODOWYCH I MOTOCYKLOWYCH

| Opis | Kod | Cena Netto | EYE-LIGHT PLUS | EM9980 C PLUS | EM9780 C PLUS | EM9580 C Plus TOUCHSCR | EM9580 Plus TOUCHSCREEN | EM9580 C Plus | EM9580 Plus | EM9550 C Plus | EM9550 Plus | EM9380 C / TOUCHSCREEN | EM9380 / TOUCHSCREEN | EM9350 C | EM9350 | EM9280 C | EM9280 | EM9250 C PREMIUM | EM9250 PREMIUM | EM9250 PROFESSIONAL | EM9250 BASIC | EM9250 BASIC BIKELINE |
|-------------------------------------------------------------------------------------|--------------------------------------------------------------------------------------------------------------------------------------|-------------------|-----------------------------------|---------------|---------------|------------------------|-------------------------|---------------|-------------|---------------|-------------|------------------------|----------------------|----------|--------|----------|--------|------------------|----------------|---------------------|--------------|-----------------------|
| | | | ZESTAWY DO CENTROWANIA KÓŁ | | | | | | | | | | | | | | | | | | | |
|  | Tuleja B6 „Racing” Ø 67 mm do FERRARI / MASERATI | 8-21100083 | 420,00 | O | O | O | O | O | O | O | O | O | O | O | O | O | O | O | O | O | O | O |
|  | Tuleja B9 OPEL Ø 56,5-65-70,1 mm | 8-21100085 | 420,00 | O | O | O | O | O | O | O | O | O | O | O | O | O | O | O | O | O | O | O |
|  | RENAULT Zestaw 5 tulei Renault | 8-21100229 | 1 535,00 | O | O | O | O | O | O | O | O | O | O | O | O | O | O | O | O | O | O | O |
| | B10 Ø 60 mm | 4-105106 | | | | | | | | | | | | | | | | | | | | |
| | B12 Ø 66 mm | 4-107025 | | | | | | | | | | | | | | | | | | | | |
| | B13 Ø 71 mm | 4-107026 | | | | | | | | | | | | | | | | | | | | |
| | B14 Ø 89 mm | 4-107027 | | | | | | | | | | | | | | | | | | | | |
| | B15 Ø 130 mm | 4-107028 | | | | | | | | | | | | | | | | | | | | |
|  | Zestaw BMW/MINI Ø 66,5 / Ø 56,5 - Ø 72,5 - Ø 74 mm B6 - Ø 66.5 mm - 4-105103 B11 - Ø 56.5 - Ø 72.5 - Ø 74 mm - 4-105108 | 8-21100228 | 777,00 | O | O | O | O | O | O | O | O | O | O | O | O | O | O | O | O | O | O | O |
|  | Zestaw MERCEDES Ø 57. Ø 65, Ø 66,5, Ø 84 mm | 8-21400022 | 792,00 | O | O | O | O | O | O | O | O | O | O | O | O | O | O | O | O | O | O | O |
| | B16 Ø 57, Ø 66,5, Ø 67 mm | 4-138168 | | | | | | | | | | | | | | | | | | | | |
| | B17 Ø 60, Ø 84 mm | 4-138169 | | | | | | | | | | | | | | | | | | | | |

■ = Standard O = Kompatybilne - = NIEkompatybilne

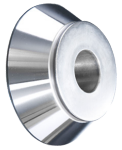



AKCESORIA DO WYWAŻAREK SAMOCHODOWYCH I MOTOCYKLOWYCH

| Opis | Kod | Cena netto | EYE-LIGHT PLUS | EM9980 C PLUS | EM9780 C PLUS | EM9580 C Plus TouchScr | EM9580 Plus TOUCHSCREEN | EM9680 C Plus | EM9580 Plus | EM9550 C Plus | EM9550 Plus | EM9380 C / TOUCHSCREEN | EM9380 / TOUCHSCREEN | EM9350 C | EM9350 | EM9280 C | EM9280 | EM9250 C PREMIUM | EM9250 PREMIUM | EM9250 PROFESSIONAL | EM9250 Basic | EM9250 Basic BIKELINE | | | | | | | | | |
|-------------------------------------------------------------------------------------------------------------|-----------------------------------------------------------------------------------------------------------------------------------------------------------------------------------------------------------------------------------------------------------------------------------------------------------------------------------------------------------------------------------------------|------------|--------------------------------------|---------------|---------------|--------------------------------------------------|-------------------------|---------------|-------------------------------|---------------|-------------|------------------------|----------------------|----------|--------|----------|--------|------------------|----------------|---------------------|--------------|-----------------------|---|---|---|---|---|---|---|---|---|
| | | | | | | | | | | | | | | | | | | | | | | | | | | | | | | | |
| CENTROWANIE KOŁA | | | | | | | | | | | | | | | | | | | | | | | | | | | | | | | |
|  <p>CIP</p> | <p>CIP Stożek pośredni Ø 55÷72 mm Niezastąpione akcesorium do kół z plastikowymi kołpakami i kół z krótkimi otworami w piasku. Wymiary CIP zapobiegają jego wystawianiu przez otwór piasty z przodu, zapobiegając uszkodzeniu przodu koła, ponieważ w tych kołach przednia średnica otworu piasty jest mniejsza niż średnica tylnego otworu centrującego.</p> | 8-21100200 | 312,00 | ○ | ○ | ○ | ○ | ○ | ○ | ○ | ○ | ○ | ○ | ○ | ○ | ○ | ○ | ○ | ○ | ○ | ○ | ○ | ○ | | | | | | | | |
|  <p>CGF PCF1 CF1</p> | <p>ARF Akcesorium do kół terenowych Ø102,5÷118,5mm Ø 101÷119 mm.</p> <table border="1"> <tr> <td>CGF</td> <td>Stożek do kół terenowych (dostawcze)</td> <td>5-107971</td> </tr> <tr> <td>PCF1</td> <td>Ochroniacz koła do centrowania felg aluminiowych</td> <td>4-115868</td> </tr> <tr> <td>CF1</td> <td>Kołpak mocujący koła ø 147 mm</td> <td>4-115863</td> </tr> </table> | CGF | Stożek do kół terenowych (dostawcze) | 5-107971 | PCF1 | Ochroniacz koła do centrowania felg aluminiowych | 4-115868 | CF1 | Kołpak mocujący koła ø 147 mm | 4-115863 | 8-21100080 | 500,00 | ■ | ■ | ■ | ■ | ■ | ■ | ■ | ■ | ■ | ■ | ■ | ■ | ■ | ■ | ■ | ■ | ■ | ■ | ○ |
| CGF | Stożek do kół terenowych (dostawcze) | 5-107971 | | | | | | | | | | | | | | | | | | | | | | | | | | | | | |
| PCF1 | Ochroniacz koła do centrowania felg aluminiowych | 4-115868 | | | | | | | | | | | | | | | | | | | | | | | | | | | | | |
| CF1 | Kołpak mocujący koła ø 147 mm | 4-115863 | | | | | | | | | | | | | | | | | | | | | | | | | | | | | |
|  | <p>Stożek centrujący Ø95 do Ø137 mm.</p> | 8-21100096 | 773,00 | ○ | ○ | ○ | ○ | ○ | ○ | ○ | ○ | ○ | ○ | ○ | ○ | ○ | ○ | ○ | ○ | ○ | ○ | ○ | ○ | | | | | | | | |
|  <p>DX2 CST</p> | <p>Stożek do lekkich ciężarówek Ø 110÷132 mm.</p> <table border="1"> <tr> <td>DX2</td> <td>podkładka dystansowa</td> <td>341843</td> </tr> <tr> <td>CST</td> <td>Stożek do lekkiej ciężarówki ø 110÷132 mm</td> <td>4-112320</td> </tr> </table> | DX2 | podkładka dystansowa | 341843 | CST | Stożek do lekkiej ciężarówki ø 110÷132 mm | 4-112320 | 8-21100201 | 726,00 | ○ | ○ | ○ | ○ | ○ | ○ | ○ | ○ | ○ | ○ | ○ | ○ | ○ | ○ | ○ | ○ | ○ | ○ | ○ | | | |
| DX2 | podkładka dystansowa | 341843 | | | | | | | | | | | | | | | | | | | | | | | | | | | | | |
| CST | Stożek do lekkiej ciężarówki ø 110÷132 mm | 4-112320 | | | | | | | | | | | | | | | | | | | | | | | | | | | | | |

■ = Standard ○ = Kompatybilne - = NIEkompatybilne



AKCESORIA DO WYWAŻAREK SAMOCHODOWYCH I MOTOCYKLOWYCH





| Opis | Kod | Cena netto | EYE-LIGHT PLUS | EM9980 C PLUS | EM9780 C PLUS | EM9580 C Plus TOUCHSCR | EM9580 Plus TOUCHSCREEN | EM9580 C Plus | EM9580 Plus | EM9550 C Plus | EM9550 Plus | EM9380 C / TOUCHSCREEN | EM9380 / TOUCHSCREEN | EM9350 C | EM9350 | EM9280 C | EM9280 | EM9250 C PREMIUM | EM9250 PREMIUM | EM9250 PROFESSIONAL | EM9250 BASIC | EM9250 Basic BikeLine | |
|------------------------------------------------------------------------------------------------------------|----------------------------------------------------------------------------------------------------------------------------------------------------|-------------------|------------------|---------------|---------------|------------------------|-------------------------|---------------|-------------|---------------|-------------|------------------------|----------------------|----------|--------|----------|--------|------------------|----------------|---------------------|--------------|-----------------------|---|
| | | | CENTROWANIE KOŁA | | | | | | | | | | | | | | | | | | | | |
|  <p>DX1 CF1 CF2</p> | DX/CBF Akcesorium centrujące do kół samochodów dostawczych i terenowych z centralnym otworem o średnicy 117÷173 mm. | 8-21100141 | 1 620,00 | O | O | O | O | O | O | O | O | O | O | O | O | O | O | O | O | O | O | O | O |
| | DX1 Nasadka dystansowa | 4-107426 | | | | | | | | | | | | | | | | | | | | | |
| | CF1 Stożek do samochodów dostawczych ø 117÷147 mm | 4-107423 | | | | | | | | | | | | | | | | | | | | | |
| | CF2 Stożek do samochodów dostawczych 143÷173 mm | 4-107424 | | | | | | | | | | | | | | | | | | | | | |
|  <p>DX1 CF161</p> | DX1/CF161 Professional centring kits for Mercedes Benz Sprinter and Volkswagen Crafter commercial vehicles with central hole with Ø 161 mm. | 8-21120004 | 1 097,00 | O | O | O | O | O | O | O | O | O | O | O | O | O | O | O | O | O | O | O | |
| | DX1 Nasadka dystansowa | 4-107426 | | | | | | | | | | | | | | | | | | | | | |
| | CF161 Stożek centrujący Ø 161 mm | 4-131929 | | | | | | | | | | | | | | | | | | | | | |
| NASADKI DYSTANSOWE | | | | | | | | | | | | | | | | | | | | | | | |
|  | DM Nasadka dystansowa Ø 40 mm | 8-21100088 | 335,00 | O | O | O | O | O | O | O | O | O | O | O | O | O | O | O | O | O | O | O | |
|  <p>ARS DARS</p> | ARS Racing akcesorium do kół sportowych, do użytku z tuleją wyścigową | 8-21100089 | 1 177,00 | O | O | O | O | O | O | O | O | O | O | O | O | O | O | O | O | O | O | O | |

■ = Standard O = Kompatybilne - = NIEkompatybilne

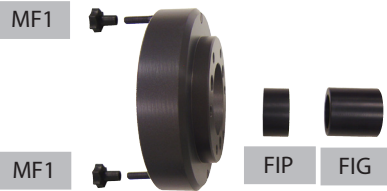

www.corgi.pl

AKCESORIA DO WYWAŻAREK SAMOCHODOWYCH I MOTOCYKLOWYCH

| | Opis | Kod | Cena netto | EYE-LIGHT PLUS | EM9980 C PLUS | EM9780 C PLUS | EM9680 C Plus TouchScr | EM9580 Plus TOUCHSCREEN | EM9580 C Plus | EM9580 Plus | EM9550 C Plus | EM9550 Plus | EM9380 C / TOUCHSCREEN | EM9380 / TOUCHSCREEN | EM9350 C | EM9350 | EM9280 C | EM9280 | EM9250 C PREMIUM | EM9250 PREMIUM | EM9250 PROFESSIONAL | EM9250 Basic | EM9250 Basic BiKELINE | | | | | | | |
|-------------------------------------------------------------------------------------|----------------------------------------------------------------------------------------------------------------------------------------------------------------------------------------------------------------------------------------------------------------------------------------------------------|----------------------------|-----------------------------|-----------------|---------------|----------------------------|------------------------|-------------------------|-----------------------|---------------|---------------|-------------|------------------------|----------------------|----------|--------|----------|--------|------------------|----------------|---------------------|--------------|-----------------------|--|--|--|--|--|--|--|
| NASADKI DYSTANSOWE | | | | | | | | | | | | | | | | | | | | | | | | | | | | | | |
|  | ARF1 Specjalna flansa do kół F1 Akcesorium do kół F1 kompatybilne z mocowaniami Ferrari, McLaren i Toyota. | 8-21100093 | 2 749,00 | O | O | O | O | O | O | O | O | O | O | O | O | O | O | O | O | O | O | O | O | | | | | | | |
| | <table border="1"> <tr> <td>FIG</td> <td>Nasadka dystansowa L=60 mm</td> <td>4-105181</td> </tr> <tr> <td>FIP</td> <td>Nasadka dystansowa L=30 mm</td> <td>4-105171</td> </tr> <tr> <td>MF1</td> <td>Uchwyt do dystansu F1</td> <td>459932</td> </tr> </table> | FIG | Nasadka dystansowa L=60 mm | 4-105181 | FIP | Nasadka dystansowa L=30 mm | 4-105171 | MF1 | Uchwyt do dystansu F1 | 459932 | | | | | | | | | | | | | | | | | | | | |
| | FIG | Nasadka dystansowa L=60 mm | 4-105181 | | | | | | | | | | | | | | | | | | | | | | | | | | | |
| | FIP | Nasadka dystansowa L=30 mm | 4-105171 | | | | | | | | | | | | | | | | | | | | | | | | | | | |
| MF1 | Uchwyt do dystansu F1 | 459932 | | | | | | | | | | | | | | | | | | | | | | | | | | | | |
| | | | | | | | | | | | | | | | | | | | | | | | | | | | | | | |
| | | | | | | | | | | | | | | | | | | | | | | | | | | | | | | |
| MOCOWANIE KÓŁ - RÓŻNE AKCESORIA | | | | | | | | | | | | | | | | | | | | | | | | | | | | | | |
|  | VGBP Koło ręczne do pierścienia mocowania koła. | 802260682 | 429,00 | - | - | - | - | O | - | O | - | O | - | O | - | O | - | O | - | O | O | O | O | | | | | | | |
|  | Nasadka CBG do mocowania felg aluminiowych Ø 210 mm | 802459564 | 339,00 | O | O | O | O | O | O | O | O | O | O | O | O | O | O | O | O | O | O | O | O | | | | | | | |
| | <table border="1"> <tr> <td>OR</td> <td>Elastyczny gumowy pierścień</td> <td>462817</td> </tr> </table> | OR | Elastyczny gumowy pierścień | 462817 | | | | | | | | | | | | | | | | | | | | | | | | | | |
| OR | Elastyczny gumowy pierścień | 462817 | | | | | | | | | | | | | | | | | | | | | | | | | | | | |
|  | Szybka blokada QLN . Możliwość montażu we wszystkich modelach z gwintowaną piastą Ø 40 mm. Akcesorium z pistoletem pneumatycznym do mocowania. | 8-21100095 | 2 866,00 | - | - | - | - | O | - | O | - | O | - | O | - | O | - | O | - | O | O | O | O | | | | | | | |

■ = Standard O = Kompatybilne - = NIEkompatybilne



www.corgi.pl

AKCESORIA DO WYWAŻAREK SAMOCHODOWYCH I MOTOCYKLOWYCH

FLANSZE DO MOCOWANIA KÓŁ Z OTWOREM CENTRALNYM

Do równomiernego dokręcenia kół, bezpośrednio w otworach montażowych felgi, rozkładając nacisk docisku wokół środkowego otworu tak, jak śruby mocujące koło w pojeździe, dostępne są przednie flansze sworzniowe PPF PREMIUM.

Flansze te są stosowane zamiast zewnętrznej nasadki mocującej i zawsze powinny być dopasowane do stożka centrującego lub tulei centrującej, zapewniając praktycznie bezbłędne centrowanie. Flansze PPF PREMIUM są uniwersalne, intuicyjne i łatwe w obsłudze.

Regulacja PCD jest szybka i może być stosowana do wszystkich typów felg samochodów osobowych, dostawczych i SUV-ów z centralnym otworem, zarówno obecnych, jak i przeszłych.

Wysoka jakość wyników dla każdego wyważania bez poświęcania cennego czasu.

PRZYKŁAD UŻYCIA

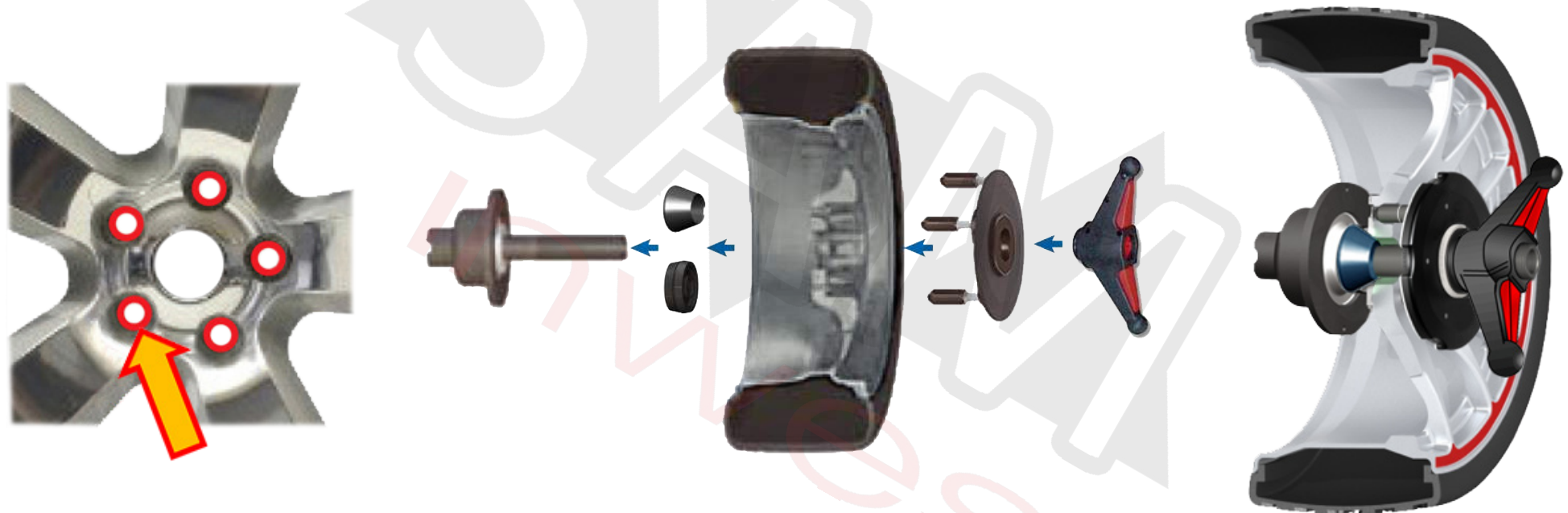

















■ = Standard

○ = Kompatybilne



- = NIEkompatybilne

AKCESORIA DO WYWAŻAREK SAMOCHODOWYCH I MOTOCYKLOWYCH

| Opis | Kod | Cena netto | EYE-LIGHT PLUS | EM9980 C PLUS | EM9780 C PLUS | EM9680 C Plus TOUCHSCR | EM9580 Plus TOUCHSCREEN | EM9580 C Plus | EM9580 Plus | EM9550 C Plus | EM9550 Plus | EM9380 C / TOUCHSCREEN | EM9380 / TOUCHSCREEN | EM9350 C | EM9350 | EM9280 C | EM9280 | EM9250 C PREMIUM | EM9250 PREMIUM | EM9250 PROFESSIONAL | EM9250 BASIC | EM9250 BASIC BIKE LINE | |
|-----------------------------------------------------------------------------------------------------------------------------------------------------------------------------------------------------------------------------------------------------------------------------------------------------------------------------------------------------------------------------------------------------------------------------------------------------------------------------------------------------------------------------------------------------------------------------------------------------------------------------------------------------------------|----------------------------------------------------------------------------------------------------------------------------------------------------------------|-------------------|-----------------|---------------|---------------|------------------------|-------------------------|---------------|-------------|---------------|-------------|------------------------|----------------------|----------|--------|----------|--------|------------------|----------------|---------------------|--------------|------------------------|--|
| | | | | | | | | | | | | | | | | | | | | | | | |
| FLANSZE DO MOCOWANIA KÓŁ Z OTWOREM CENTRALNYM | | | | | | | | | | | | | | | | | | | | | | | |
|  <p>per cerchi a 5 fori. Range bloccaggio 95,25 - 180 mm</p> <ul style="list-style-type: none">  Ø 28  Ø 22,5  Ø 22,5  Ø 19 | <p>PFM FASTPLATE 5 do felg 5-otworowych. Zakres mocowania: 95,25 ÷ 180 mm</p> | 8-21100294 | 2 398,00 | O | O | O | O | O | O | O | O | O | O | O | O | O | O | O | O | O | O | O | |
|  <p>per cerchi a 3-4-6-8 fori. Range bloccaggio 95,25 - 180 mm</p> <ul style="list-style-type: none">  Ø 28  Ø 22,5  Ø 22,5  Ø 19 | <p>PFM FASTPLATE 3-4-6-8 dla 3-4-6-8-otworów felgi. Zakres mocowania: 95,25 ÷ 180 mm</p> | 8-21100295 | 2 704,00 | O | O | O | O | O | O | O | O | O | O | O | O | O | O | O | O | O | O | O | |
|  <p>8-21100296 PFM FASTPLATE KIT per cerchi a 3-4-5-6-8 fori. Range bloccaggio 95,25 - 180 mm</p> <ul style="list-style-type: none">  Ø 28  Ø 22,5  Ø 22,5  Ø 19 | <p>PFM FASTPLATE KIT Do felg z 3-4-5-6-8 otworami. (zawiera 8-21100294 i 8-21100295)</p> | 8-21100296 | 4 833,00 | O | O | O | O | O | O | O | O | O | O | O | O | O | O | O | O | O | O | O | |
|  | <p>PFM-C SLEEVE HANDLE Tuleja do wyważarek z automatycznym mocowaniem. Do przykręcenia bezpośrednio do FASTPLATE, aby pracować wygodniej i szybciej</p> | 8-21100297 | 421,00 | O | O | O | O | - | O | - | O | - | O | - | O | - | O | - | O | - | O | - | |

■ = Standard O = Kompatybilne - = NIEkompatybilne

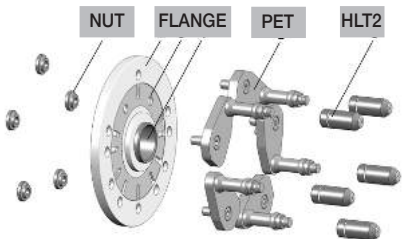
AKCESORIA DO WYWAŻAREK SAMOCHODOWYCH I MOTOCYKLOWYCH

| | Opis | Kod | Cena netto | EYE-LIGHT PLUS | EM9980 C PLUS | EM9780 C PLUS | EM9580 C Plus TouchScr | EM9580 Plus TOUCHSCREEN | EM9580 C Plus | EM9580 Plus | EM9550 C Plus | EM9550 Plus | EM9380 C / TOUCHSCREEN | EM9380 / TOUCHSCREEN | EM9350 C | EM9350 | EM9280 C | EM9280 | EM9250 C PREMIUM | EM9250 PREMIUM | EM9250 PROFESSIONAL | EM9250 BASIC | EM9250 BASIC BIKELINE |
|------------------------------------------------------------------------------------|-----------------------------------------------------------------------------------------------|-------------------|-----------------|----------------|---------------|---------------|------------------------|-------------------------|---------------|-------------|---------------|-------------|------------------------|----------------------|----------|--------|----------|--------|------------------|----------------|---------------------|--------------|-----------------------|
| | | | | | | | | | | | | | | | | | | | | | | | |
| FLANSZE DO MOCOWANIA KÓŁ Z OTWOREM CENTRALNYM | | | | | | | | | | | | | | | | | | | | | | | |
|  | FPF-2 BMW Uniwersalny zestaw flansz do kół z centralnym otworem (Ø 4x100/5x120/5x112). | 8-21100145 | 2 155,00 | O | O | O | O | O | O | O | O | O | O | O | O | O | O | O | O | O | O | O | O |
|  | FPF Basic Uniwersalny zestaw flansz do kół z centralnym otworem Ø 40 mm. | 8-21100152 | 2 989,00 | O | O | O | O | O | O | O | O | O | O | O | O | O | O | O | O | O | O | O | O |
| | HLT2 Nakładka ø 22,5 L 58 | 4-109127 | | | | | | | | | | | | | | | | | | | | | |
| | PET Podstawowy platek | 4-108097 | | | | | | | | | | | | | | | | | | | | | |
|  | Zestaw z 2 pokrętłami obrotowymi | 8-21100291 | 81,00 | - | - | - | - | O | - | O | - | O | - | O | - | O | - | O | - | O | O | O | O |

■ = Standard O = Kompatybilne - = NIEkompatybilne

AKCESORIA DO WYWAŻAREK SAMOCHODOWYCH I MOTOCYKLOWYCH

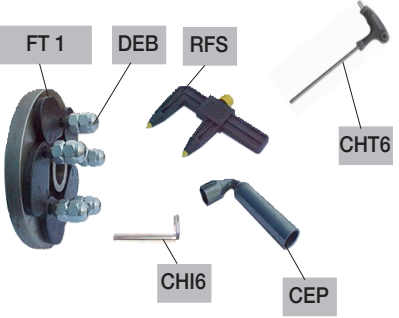
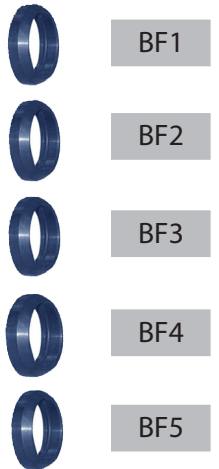



| Opis | Kod | Cena netto | EYE-LIGHT PLUS | EM9980 C PLUS | EM9780 C PLUS | EM9580 C Plus TOUCHSCR | EM9580 Plus TOUCHSCREEN | EM9580 C Plus | EM9580 Plus | EM9550 C Plus | EM9550 Plus | EM9380 C / TOUCHSCREEN | EM9380 / TOUCHSCREEN | EM9350 C | EM9350 | EM9280 C | EM9280 | EM9250 C PREMIUM | EM9250 PREMIUM | EM9250 PROFESSIONAL | EM9250 BASIC | EM9250 BASIC BIKELINE | | | | | | | | | | | | | | | | |
|----------------------------------------------------------------------------------------------------------------------------------------------------------------------|---------------------------------------------------------------|-----------------|--------------------------------------------------------------------------------------------------------------------------------------------------------------------------------------------------------------------------------------------------------------------------------------------------------------------------------------------------------------------------------------------------------------------------------------------------------------------------------------------------------------------------------------------------------------------------------------|---------------|-----------------------|------------------------|-------------------------|---------------------------------------------------------------|-----------------|---------------|---------------------------|------------------------|----------------------|------------------------------|-----------------|------------|--------------------------------|------------------|----------------|-------------------------|---------------|-----------------------|--|--|--|--|--|--|--|--|--|--|--|--|--|--|--|--|
| | | | | | | | | | | | | | | | | | | | | | | | | | | | | | | | | | | | | | | |
| FLANSZE DO MOCOWANIA KÓŁ Z OTWOREM CENTRALNYM I BEZ OTWORU CENTRALNEGO | | | | | | | | | | | | | | | | | | | | | | | | | | | | | | | | | | | | | | |
|  <p>FRU-SA D.40 Flansza uniwersalna do kół z otworem centralnym lub bez.</p> | 8-21100091 | 2 725,00 | | | | | | | | | | | | | | | | | | | | | | | | | | | | | | | | | | | | |
| | | | <table border="1"> <tr> <td>FT 1</td> <td>Korbowód ze sworzniem</td> <td>4-105873</td> </tr> <tr> <td>DEB</td> <td>Nakrętka stożkowa/kulista do mocowania koła</td> <td>321878</td> </tr> <tr> <td>CHT6</td> <td>Chiave esagonale a T CH 6</td> <td>4-105877</td> </tr> <tr> <td>RFS</td> <td>Suwmiarka</td> <td>441286</td> </tr> <tr> <td>CEP</td> <td>Klucz sześciokątny CH 22</td> <td>426517</td> </tr> <tr> <td>CHI 6</td> <td>Klucz sześciokątny CH 6</td> <td>600906</td> </tr> </table> | FT 1 | Korbowód ze sworzniem | 4-105873 | DEB | Nakrętka stożkowa/kulista do mocowania koła | 321878 | CHT6 | Chiave esagonale a T CH 6 | 4-105877 | RFS | Suwmiarka | 441286 | CEP | Klucz sześciokątny CH 22 | 426517 | CHI 6 | Klucz sześciokątny CH 6 | 600906 | | | | | | | | | | | | | | | | | |
| FT 1 | Korbowód ze sworzniem | 4-105873 | | | | | | | | | | | | | | | | | | | | | | | | | | | | | | | | | | | | |
| DEB | Nakrętka stożkowa/kulista do mocowania koła | 321878 | | | | | | | | | | | | | | | | | | | | | | | | | | | | | | | | | | | | |
| CHT6 | Chiave esagonale a T CH 6 | 4-105877 | | | | | | | | | | | | | | | | | | | | | | | | | | | | | | | | | | | | |
| RFS | Suwmiarka | 441286 | | | | | | | | | | | | | | | | | | | | | | | | | | | | | | | | | | | | |
| CEP | Klucz sześciokątny CH 22 | 426517 | | | | | | | | | | | | | | | | | | | | | | | | | | | | | | | | | | | | |
| CHI 6 | Klucz sześciokątny CH 6 | 600906 | | | | | | | | | | | | | | | | | | | | | | | | | | | | | | | | | | | | |
|  <p>BVFF Zestaw 5 tulei do precyzyjnego centrowania na flanszy FRU.</p> | 8-21100092 | 834,00 | | | | | | | | | | | | | | | | | | | | | | | | | | | | | | | | | | | | |
| | | | <table border="1"> <tr> <td>BF1</td> <td>Tuleja ø 55 Peugeot</td> <td>4-105110</td> </tr> <tr> <td>BF2</td> <td>Tuleja ø 58,1 Fiat Ritmo and Citroën CX/ Evasion, Peugeot 806</td> <td>4-105174</td> </tr> <tr> <td>BF3</td> <td>Tuleja ø 60,1 Renault</td> <td>4-105175</td> </tr> <tr> <td>BF4</td> <td>Tuleja ø 65 Peugeot, Citroën</td> <td>4-105176</td> </tr> <tr> <td>BF5</td> <td>Tuleja ø 57 BMW,VW, AUDI, SEAT</td> <td>4-106570</td> </tr> </table> | BF1 | Tuleja ø 55 Peugeot | 4-105110 | BF2 | Tuleja ø 58,1 Fiat Ritmo and Citroën CX/ Evasion, Peugeot 806 | 4-105174 | BF3 | Tuleja ø 60,1 Renault | 4-105175 | BF4 | Tuleja ø 65 Peugeot, Citroën | 4-105176 | BF5 | Tuleja ø 57 BMW,VW, AUDI, SEAT | 4-106570 | | | | | | | | | | | | | | | | | | | | |
| BF1 | Tuleja ø 55 Peugeot | 4-105110 | | | | | | | | | | | | | | | | | | | | | | | | | | | | | | | | | | | | |
| BF2 | Tuleja ø 58,1 Fiat Ritmo and Citroën CX/ Evasion, Peugeot 806 | 4-105174 | | | | | | | | | | | | | | | | | | | | | | | | | | | | | | | | | | | | |
| BF3 | Tuleja ø 60,1 Renault | 4-105175 | | | | | | | | | | | | | | | | | | | | | | | | | | | | | | | | | | | | |
| BF4 | Tuleja ø 65 Peugeot, Citroën | 4-105176 | | | | | | | | | | | | | | | | | | | | | | | | | | | | | | | | | | | | |
| BF5 | Tuleja ø 57 BMW,VW, AUDI, SEAT | 4-106570 | | | | | | | | | | | | | | | | | | | | | | | | | | | | | | | | | | | | |

■ = Standard O = Kompatybilne - = NIEkompatybilne

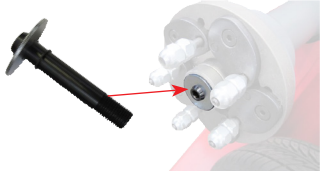

www.corgi.pl

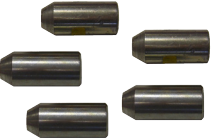
AKCESORIA DO WYWAŻAREK SAMOCHODOWYCH I MOTOCYKLOWYCH



| Opis | Kod | Cena netto | EYE-LIGHT PLUS | EM9980 C PLUS | EM9780 C PLUS | EM9580 C Plus TOUCHSCR | EM9580 Plus TOUCHSCREEN | EM9580 C Plus | EM9580 Plus | EM9550 C Plus | EM9550 Plus | EM9380 C / TOUCHSCREEN | EM9380 / TOUCHSCREEN | EM9350 C | EM9350 | EM9280 C | EM9280 | EM9250 C PREMIUM | EM9250 PREMIUM | EM9250 PROFESSIONAL | EM9250 BASIC | EM9250 BASIC BikeLINE | |
|-------------------------------------------------------------------------------------|--------------------------------------------------------------------------------------------------------------------------------------|-------------------|-------------------------------------------------------------------------------|---------------|---------------|------------------------|-------------------------|---------------|-------------|---------------|-------------|------------------------|----------------------|----------|--------|----------|--------|------------------|----------------|---------------------|--------------|-----------------------|---|
| | | | FLANSZE DO MOCOWANIA KÓŁ Z OTWOREM CENTRALNYM I BEZ OTWORU CENTRALNEGO | | | | | | | | | | | | | | | | | | | | |
|  | Tarcza blokująca do tulei BVFF pod flanszę FRU-SA, do wyważarek z dociskiem ręcznym | 8-21100207 | 90,00 | - | - | - | - | O | - | O | - | O | - | O | - | O | - | O | - | O | O | O | O |
|  | Tarcza blokująca do tulei BVFF pod flanszę FRU-SA, do wyważarek z automatycznym mocowaniem „C”. | 8-21100208 | 90,00 | O | O | O | O | - | O | - | O | - | O | - | O | - | O | - | O | - | - | - | - |
|  | BCO Zestaw pięciu podkładek stożkowych do FRU-sa do stosowania z DCL i DEB przy obróbce otworów o średnicy większej niż 21 mm | 802321387 | 231,00 | O | O | O | O | O | O | O | O | O | O | O | O | O | O | O | O | O | O | O | O |
|  | DCL Zestaw pięciu nakrętek stożkowych do felg aluminiowych z kołnierzem FRU-SA. | 802322075 | 377,00 | O | O | O | O | O | O | O | O | O | O | O | O | O | O | O | O | O | O | O | O |
|  | DMS Zestaw pięciu nakrętek kulistych do felg aluminiowych z kołnierzem FRU-SA. | 802322076 | 377,00 | O | O | O | O | O | O | O | O | O | O | O | O | O | O | O | O | O | O | O | O |

■ = Standard O = Kompatybilne - = NIEkompatybilne







www.corgi.pl

AKCESORIA DO WYWAŻAREK SAMOCHODOWYCH I MOTOCYKLOWYCH

| | Opis | Kod | Cena netto | EYE-LIGHT PLUS | EM9980 C PLUS | EM9780 C PLUS | EM9580 C Plus TouchScr | EM9580 Plus TOUCHSCREEN | EM9580 C Plus | EM9580 Plus | EM9550 C Plus | EM9550 Plus | EM9380 C / TOUCHSCREEN | EM9380 / TOUCHSCREEN | EM9350 C | EM9350 | EM9280 C | EM9280 | EM9250 C PREMIUM | EM9250 PREMIUM | EM9250 PROFESSIONAL | EM9250 BASIC | EM9250 BASIC BIKELINE | |
|-----------------------------------------------------------------------------------|---------------------------------------------------------------------------|------------------|-----------------|----------------|---------------|---------------|------------------------|-------------------------|---------------|-------------|---------------|-------------|------------------------|----------------------|----------|--------|----------|--------|------------------|----------------|---------------------|--------------|-----------------------|---|
| | | | | | | | | | | | | | | | | | | | | | | | | |
|  | DC5 Zestaw pięciu specjalnych nakrętek do Citroena C5. | 802262700 | 377,00 | O | O | O | O | O | O | O | O | O | O | O | O | O | O | O | O | O | O | O | O | O |
|  | SDR Zestaw pięciu specjalnych nakrętek do szybkiego mocowania kół. | 802231479 | 1 365,00 | O | O | O | O | O | O | O | O | O | O | O | O | O | O | O | O | O | O | O | O | O |

■ = Standard O = Kompatybilne - = NIEkompatybilne

AKCESORIA DO WYWAŻAREK SAMOCHODOWYCH I MOTOCYKLOWYCH

| Opis | Kod | Cena netto | EYE-LIGHT PLUS | EM9980 C PLUS | EM9780 C PLUS | EM9580 C Plus TouchScr | EM9580 Plus TouchSCREEN | EM9580 C Plus | EM9580 Plus | EM9550 C Plus | EM9550 Plus | EM9380 C / TOUCHSCREEN | EM9380 / TOUCHSCREEN | EM9350 C | EM9350 | EM9280 C | EM9280 | EM9250 C PREMIUM | EM9250 PREMIUM | EM9250 PROFESSIONAL | EM9250 BASIC | EM9250 BASIC BIKELINE |
|------------------------------------------------------------------------------------|-------------------------------------------------------------------------------|------------|--------------------------------------------------|---------------|---------------|------------------------|-------------------------|---------------|-------------|---------------|-------------|------------------------|----------------------|----------|--------|----------|--------|------------------|----------------|---------------------|--------------|-----------------------|
| | | | SYSTEM KALIBRACJI I WSPARCIA TECHNICZNEGO | | | | | | | | | | | | | | | | | | | |
|  | Kalibracja lasera BLCK-1 dla EM9980-C Plus, Eyclight Plus, EM9780 Plus | 8-21120001 | 0 | 0 | 0 | - | - | - | - | - | - | - | - | - | - | - | - | - | - | - | - | - |
|  | Kabel szeregowy RS232 (mbu - mbe - seb). | 8-21100224 | 137,00 | 0 | 0 | 0 | 0 | 0 | 0 | 0 | 0 | 0 | 0 | 0 | 0 | 0 | 0 | 0 | 0 | 0 | 0 | 0 |
|  | Adapter USB-RS232. | 8-21100226 | 203,00 | 0 | 0 | 0 | 0 | 0 | 0 | 0 | 0 | 0 | 0 | 0 | 0 | 0 | 0 | 0 | 0 | 0 | 0 | 0 |
|  | SLUG próbka masy do kalibracji. | 8-21100221 | 326,00 | ■ | ■ | ■ | ■ | ■ | ■ | ■ | ■ | ■ | ■ | ■ | ■ | ■ | ■ | ■ | ■ | ■ | ■ | ■ |
|  | Zestaw narzędzi. | 8-21100197 | 420,00 | 0 | 0 | 0 | 0 | 0 | 0 | 0 | 0 | 0 | 0 | 0 | 0 | 0 | 0 | 0 | 0 | 0 | 0 | 0 |

■ = Standard O = Kompatybilne - = NIEkompatybilne

AKCESORIA DO WYWAŻAREK SAMOCHODOWYCH I MOTOCYKLOWYCH

AKCESORIA CENTRUJĄCE I MOCUJĄCE DO KÓŁ MOTOCYKLOWYCH

W gamie akcesoriów do wyważarek terenowych dostępny jest nowy BIKES UNIVERSAL KIT z różnymi dodatkowymi zestawami do centrowania i dynamicznego wyważania kół motocyklowych. Łatwy w instalacji i szybki w użyciu. Idealny do małych kół do skuterów o średnicy do 21 cali typu terenowego; nie zapominając o szerokim chopperze i monoleverach bez łożysk. Wyniki wyważania doskonałe!

Uniwersalna do wszystkich wyważarek w zakresie mocowania ręcznego i automatycznego.

PRZYKŁAD UŻYCIA



Wał ze stożkami centrującymi.



Wał z tulejami centrującymi.



Wał motocykla o tej samej średnicy co łożysko pływające.

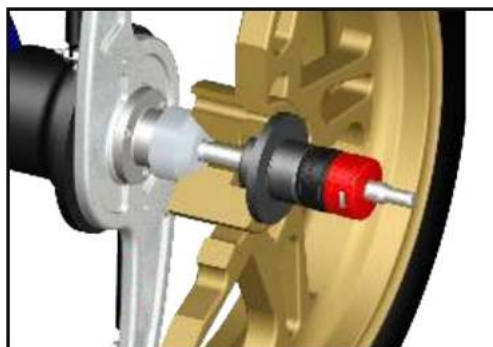

Wał ze specjalnym zestawem centrującym.

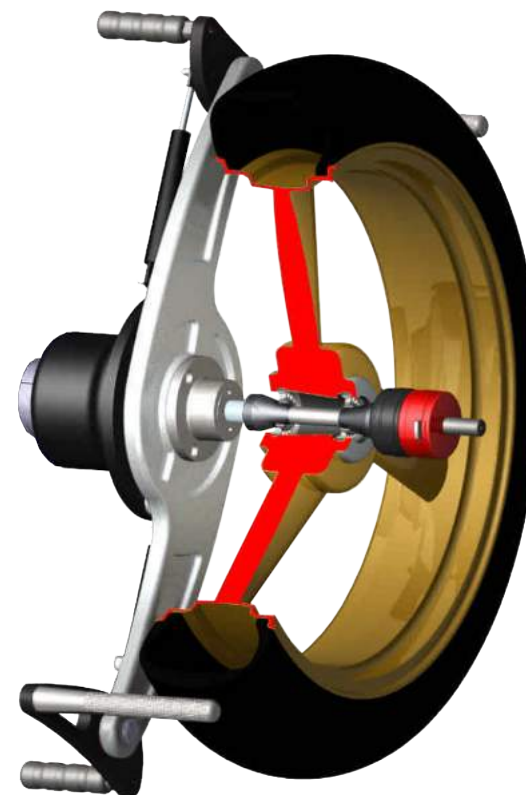

■ = Standard

O = Kompatybilne

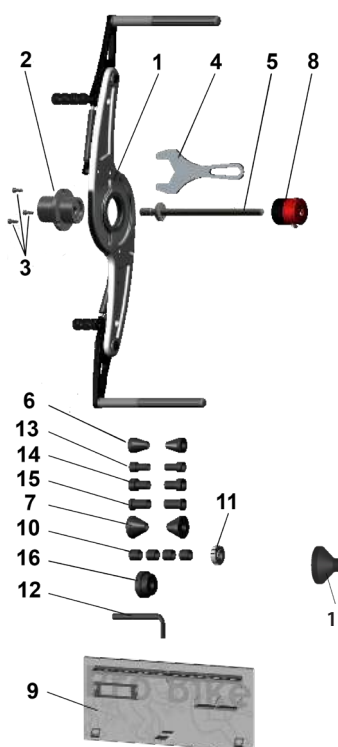
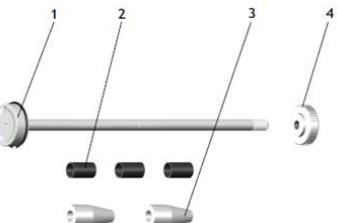

- = NIEkompatybilne

AKCESORIA DO WYWAŻAREK SAMOCHODOWYCH I MOTOCYKLOWYCH

| Opis | Kod | Cena netto | EYE-LIGHT PLUS | EM9980 C PLUS | EM9780 C PLUS | EM9580 C Plus TouchScr | EM9580 Plus TouchSCREEN | EM9580 C Plus | EM9580 Plus | EM9550 C Plus | EM9550 Plus | EM9380 C / TouchSCREEN | EM9380 / TouchSCREEN | EM9350 C | EM9350 | EM9280 C | EM9280 | EM9250 C PREMIUM | EM9250 PREMIUM | EM9250 PROFESSIONAL | EM9250 BASIC | EM9250 Basic BikeLine | |
|-------------------------------------------------------------------------------------|--------------------------------------------------------------------------------------------------------------------------------------------------------------------------------------------------|----------------------------------------|----------------|---------------|---------------|------------------------|-------------------------|---------------|-------------|---------------|-------------|------------------------|----------------------|----------|--------|----------|--------|------------------|----------------|---------------------|--------------|-----------------------|--|
| | | | | | | | | | | | | | | | | | | | | | | | |
| STANDARDOWE AKCESORIA MOTOCYKLOWE | | | | | | | | | | | | | | | | | | | | | | | |
|  | BIKE UNIVERSAL KIT 8-21120012 Podstawowe urządzenie do wyważania kół motocykli i skuterów. Wał uchwyty koła 14 mm. * Wskaźnik przedłużenia motocykla NIE jest wliczony w cenę | 4 310,00 | 0 | 0 | 0 | 0 | 0 | 0 | 0 | 0 | 0 | 0 | 0 | 0 | 0 | 0 | 0 | 0 | 0 | 0 | 0 | ■ | |
| | 1 | GRUPA PRZECIĄGAJĄCA | 3-03408 | | | | | | | | | | | | | | | | | | | | |
| | 2 | UCHWYT CYLINDRYCZNY | 3-03409 | | | | | | | | | | | | | | | | | | | | |
| | 3 | ŚRUBA Z GNIAZDEM SZEŚCIOKĄTNYM M 6X14 | 3-03410 | | | | | | | | | | | | | | | | | | | | |
| | 4 | KLUCZ JEDNOGŁÓWKOWY SW50 | 3-03411 | | | | | | | | | | | | | | | | | | | | |
| | 5 | WAŁ UCHWYTU KOŁA Ø 14 MM | 3-03412 | | | | | | | | | | | | | | | | | | | | |
| | 6 | STOŻEK CENTRUJĄCY 15÷30 MM | 3-03413 | | | | | | | | | | | | | | | | | | | | |
| | 7 | STOŻEK CENTRUJĄCY 16÷45 MM | 3-03414 | | | | | | | | | | | | | | | | | | | | |
| | 8 | SZYBKIE MOCOWANIE DO TRZPIENIA Ø 14 MM | 3-03415 | | | | | | | | | | | | | | | | | | | | |
| | 9 | PLYTA SCIENNA | 3-03416 | | | | | | | | | | | | | | | | | | | | |
| | 10 | KRÓTKI DYSTANS | 3-03417 | | | | | | | | | | | | | | | | | | | | |
| | 11 | M 14 NAKRĘTKA radełkowana | 3-03418 | | | | | | | | | | | | | | | | | | | | |
| | 12 | KLUCZ Z GNIAZDEM SZEŚCIOKĄTNYM SW4 | 3-03419 | | | | | | | | | | | | | | | | | | | | |
| | 13 | TULEJA CENTRUJĄCA Ø 15 MM | 3-03420 | | | | | | | | | | | | | | | | | | | | |
| | 14 | TULEJA CENTRUJĄCA Ø 17 MM | 3-03421 | | | | | | | | | | | | | | | | | | | | |
| | 15 | TULEJA CENTRUJĄCA Ø 20 MM | 3-03422 | | | | | | | | | | | | | | | | | | | | |
| | 16 | TULEJA CENTRUJĄCA PIAGGIO | 3-03423 | | | | | | | | | | | | | | | | | | | | |
| 17 | CIŚNIENIE BMW/HONDA | 3-03407 | | | | | | | | | | | | | | | | | | | | | |
|  | Ø10mm Wałek centrujący extra-długi 230mm, do ewentualnego uzupełnienia kodu 8-21120012 8-21100257 | 1 107,00 | 0 | 0 | 0 | 0 | 0 | 0 | 0 | 0 | 0 | 0 | 0 | 0 | 0 | 0 | 0 | 0 | 0 | 0 | 0 | 0 | |
| | 1 | WAŁ Ø 10 MM | 3-03864 | | | | | | | | | | | | | | | | | | | | |
| | 2 | SPACER | 3-03865 | | | | | | | | | | | | | | | | | | | | |
| | 3 | CENTERING CONE D. 12÷20 MM | 3-03866 | | | | | | | | | | | | | | | | | | | | |
| 4 | RING NUT M 10 | 3-03867 | | | | | | | | | | | | | | | | | | | | | |

■ = Standard O = Kompatybilne - = NIEkompatybilne

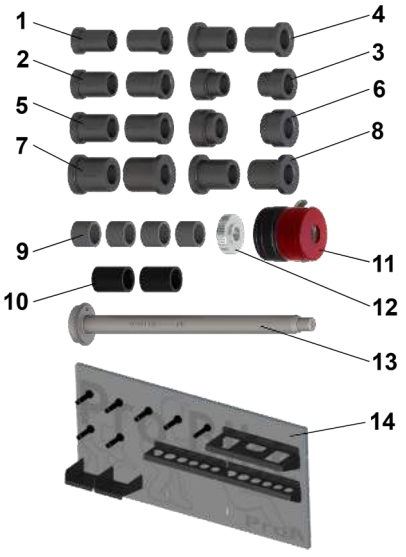

AKCESORIA DO WYWAŻAREK SAMOCHODOWYCH I MOTOCYKLOWYCH

| | Opis | Kod | Cena netto | EYE-LIGHT PLUS | EM9980 C PLUS | EM9780 C PLUS | EM9580 C Plus TouchScr | EM9580 Plus TouchSCREEN | EM9580 C Plus | EM9580 Plus | EM9550 C Plus | EM9550 Plus | EM9380 C / TouchSCREEN | EM9380 / TouchSCREEN | EM9350 C | EM9350 | EM9280 C | EM9280 | EM9250 C PREMIUM | EM9250 PREMIUM | EM9250 PROFESSIONAL | EM9250 BASIC | EM9250 BASIC BikeLINE | | | | | | | | | | | | | | | | | | | | | | | | | | | | | | | | | | | | | | | | |
|------------------------------------------------------------------------------------|---------------------------------------------------------------------------------------------------------------------------------------------------------------------------------------------------------------------------------------------------------------------------------------------------------------------------------------------------------------------------------------------------------------------------------------------------------------------------------------------------------------------------------------------------------------------------------------------------------------------------------------------------------------------------------------------------------------------------------------------------------------------------------------------------------------------------------------------------------------------------------------------------------------------------------------------------------------------------------------------------------------------------------------------------------------|------------|----------------------------|----------------|---------------|------------------------------|------------------------|-------------------------|----------------------------|-------------|---------------|----------------------------|------------------------|----------------------|----------------------------|---------|----------|----------------------------|------------------|----------------|----------------------------|--------------|-----------------------|----------------------------|---------|---|--------------------------|---------|----|---------------------------------|---------|----|--------------------------------|---------|----|---------------------------|---------|----|----------------------------|---------|----|---------------|---------|--|--|--|--|--|--|--|--|--|--|--|--|--|--|--|--|--|--|--|--|
| STANDARDOWE AKCESORIA MOTOCYKLOWE | | | | | | | | | | | | | | | | | | | | | | | | | | | | | | | | | | | | | | | | | | | | | | | | | | | | | | | | | | | | | | | |
|  | PRA3 Motocyklowe przedłużenie czujnika. <u>Do modeli z klipsem.</u> | 8-21100116 | 495,00 | - | - | - | O | O | O | O | O | O | O | O | O | O | O | O | O | O | O | O | O | | | | | | | | | | | | | | | | | | | | | | | | | | | | | | | | | | | | | | | | |
|  | PRA4 Motocyklowe przedłużenie czujnika. <u>Do modeli bez klipsa.</u> | 8-21100155 | 495,00 | - | - | - | - | - | - | - | - | - | O | O | O | O | O | O | O | O | O | O | ■ | | | | | | | | | | | | | | | | | | | | | | | | | | | | | | | | | | | | | | | | |
|  | BIKE UPGRADE KIT 19 Dodatkowy moduł do BIKE UNIVERSAL KIT. | 8-21120013 | 2 523,00 | O | O | O | O | O | O | O | O | O | O | O | O | O | O | O | O | O | O | O | O | | | | | | | | | | | | | | | | | | | | | | | | | | | | | | | | | | | | | | | | |
| | <table border="1"> <tr><td>1</td><td>TULEJA CENTRUJĄCA D. 22 mm</td><td>3-03383</td></tr> <tr><td>2</td><td>TULEJA CENTRUJĄCA D. 25,4 mm</td><td>3-03384</td></tr> <tr><td>3</td><td>TULEJA CENTRUJĄCA D. 25 mm</td><td>3-03385</td></tr> <tr><td>4</td><td>TULEJA CENTRUJĄCA D. 26 mm</td><td>3-03386</td></tr> <tr><td>5</td><td>TULEJA CENTRUJĄCA D. 28 mm</td><td>3-03387</td></tr> <tr><td>6</td><td>TULEJA CENTRUJĄCA D. 32 mm</td><td>3-03388</td></tr> <tr><td>7</td><td>TULEJA CENTRUJĄCA D. 35 mm</td><td>3-03389</td></tr> <tr><td>8</td><td>TULEJA CENTRUJĄCA D. 30 mm</td><td>3-03390</td></tr> <tr><td>9</td><td>KRÓTKI DYSTANS Śr. 20 mm</td><td>3-03391</td></tr> <tr><td>10</td><td>HARLEY D. PRZEŁĄCZNIK CIŚNIENIA</td><td>3-03392</td></tr> <tr><td>11</td><td>SZYBKE MOCOWANIE DO WAŁU D. 19</td><td>3-03393</td></tr> <tr><td>12</td><td>M 14 NAKRĘTKA radełkowana</td><td>3-03418</td></tr> <tr><td>13</td><td>WAŁ UCHWYTU KOŁA Śr. 19 mm</td><td>3-03396</td></tr> <tr><td>14</td><td>PŁYTA ŚCIENNA</td><td>3-03395</td></tr> </table> | 1 | TULEJA CENTRUJĄCA D. 22 mm | 3-03383 | 2 | TULEJA CENTRUJĄCA D. 25,4 mm | 3-03384 | 3 | TULEJA CENTRUJĄCA D. 25 mm | 3-03385 | 4 | TULEJA CENTRUJĄCA D. 26 mm | 3-03386 | 5 | TULEJA CENTRUJĄCA D. 28 mm | 3-03387 | 6 | TULEJA CENTRUJĄCA D. 32 mm | 3-03388 | 7 | TULEJA CENTRUJĄCA D. 35 mm | 3-03389 | 8 | TULEJA CENTRUJĄCA D. 30 mm | 3-03390 | 9 | KRÓTKI DYSTANS Śr. 20 mm | 3-03391 | 10 | HARLEY D. PRZEŁĄCZNIK CIŚNIENIA | 3-03392 | 11 | SZYBKE MOCOWANIE DO WAŁU D. 19 | 3-03393 | 12 | M 14 NAKRĘTKA radełkowana | 3-03418 | 13 | WAŁ UCHWYTU KOŁA Śr. 19 mm | 3-03396 | 14 | PŁYTA ŚCIENNA | 3-03395 | | | | | | | | | | | | | | | | | | | | |
| 1 | TULEJA CENTRUJĄCA D. 22 mm | 3-03383 | | | | | | | | | | | | | | | | | | | | | | | | | | | | | | | | | | | | | | | | | | | | | | | | | | | | | | | | | | | | | |
| 2 | TULEJA CENTRUJĄCA D. 25,4 mm | 3-03384 | | | | | | | | | | | | | | | | | | | | | | | | | | | | | | | | | | | | | | | | | | | | | | | | | | | | | | | | | | | | | |
| 3 | TULEJA CENTRUJĄCA D. 25 mm | 3-03385 | | | | | | | | | | | | | | | | | | | | | | | | | | | | | | | | | | | | | | | | | | | | | | | | | | | | | | | | | | | | | |
| 4 | TULEJA CENTRUJĄCA D. 26 mm | 3-03386 | | | | | | | | | | | | | | | | | | | | | | | | | | | | | | | | | | | | | | | | | | | | | | | | | | | | | | | | | | | | | |
| 5 | TULEJA CENTRUJĄCA D. 28 mm | 3-03387 | | | | | | | | | | | | | | | | | | | | | | | | | | | | | | | | | | | | | | | | | | | | | | | | | | | | | | | | | | | | | |
| 6 | TULEJA CENTRUJĄCA D. 32 mm | 3-03388 | | | | | | | | | | | | | | | | | | | | | | | | | | | | | | | | | | | | | | | | | | | | | | | | | | | | | | | | | | | | | |
| 7 | TULEJA CENTRUJĄCA D. 35 mm | 3-03389 | | | | | | | | | | | | | | | | | | | | | | | | | | | | | | | | | | | | | | | | | | | | | | | | | | | | | | | | | | | | | |
| 8 | TULEJA CENTRUJĄCA D. 30 mm | 3-03390 | | | | | | | | | | | | | | | | | | | | | | | | | | | | | | | | | | | | | | | | | | | | | | | | | | | | | | | | | | | | | |
| 9 | KRÓTKI DYSTANS Śr. 20 mm | 3-03391 | | | | | | | | | | | | | | | | | | | | | | | | | | | | | | | | | | | | | | | | | | | | | | | | | | | | | | | | | | | | | |
| 10 | HARLEY D. PRZEŁĄCZNIK CIŚNIENIA | 3-03392 | | | | | | | | | | | | | | | | | | | | | | | | | | | | | | | | | | | | | | | | | | | | | | | | | | | | | | | | | | | | | |
| 11 | SZYBKE MOCOWANIE DO WAŁU D. 19 | 3-03393 | | | | | | | | | | | | | | | | | | | | | | | | | | | | | | | | | | | | | | | | | | | | | | | | | | | | | | | | | | | | | |
| 12 | M 14 NAKRĘTKA radełkowana | 3-03418 | | | | | | | | | | | | | | | | | | | | | | | | | | | | | | | | | | | | | | | | | | | | | | | | | | | | | | | | | | | | | |
| 13 | WAŁ UCHWYTU KOŁA Śr. 19 mm | 3-03396 | | | | | | | | | | | | | | | | | | | | | | | | | | | | | | | | | | | | | | | | | | | | | | | | | | | | | | | | | | | | | |
| 14 | PŁYTA ŚCIENNA | 3-03395 | | | | | | | | | | | | | | | | | | | | | | | | | | | | | | | | | | | | | | | | | | | | | | | | | | | | | | | | | | | | | |

■ = Standard O = Kompatybilne - = NIEkompatybilne

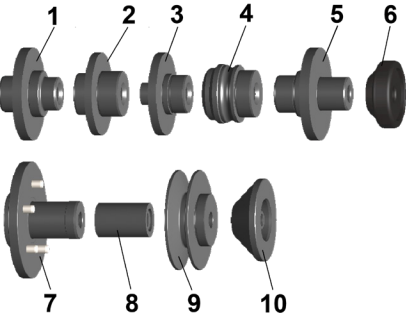

AKCESORIA DO WYWAŻAREK SAMOCHODOWYCH I MOTOCYKLOWYCH

| Opis | Kod | Cena netto | EYE-LIGHT PLUS | EM9980 C PLUS | EM9780 C PLUS | EM9580 C Plus TouchScr | EM9580 Plus TouchSCREEN | EM9580 C Plus | EM9580 Plus | EM9550 C Plus | EM9550 Plus | EM9380 C / TOUCHSCREEN | EM9380 / TOUCHSCREEN | EM9350 C | EM9350 | EM9280 C | EM9280 | EM9250 C PREMIUM | EM9250 PREMIUM | EM9250 PROFESSIONAL | EM9250 BASIC | EM9250 BASIC BikeLine | | | | | | | | | | | | | | | | | | | | | | | | | | | | | | |
|--------------------------------------------------------------------------------------------------------------------------------------------------------------------------------------------------------------------------------------------------------------------------------------------------------------------------------------------------------------------------------------------------------------------------------------------------------------------------------------------------------------------------------------------------------------------------------------------------------------------------------------------------------------------------------------------------------------------------------------------------------------------------------------------------------------------------------------------------------------------------------------------------------------------------------------------------------------------------------------------------------------------------------------------------------------------------------------------------------------------------------------------------------------------------------------------------------|------------|----------------------------------------------------------------------------------------------------------------|-----------------------------------|---------------|-----------------------------------|------------------------|-------------------------|-------------------------------------------|-------------|---------------|--------------------------------------|------------------------|----------------------|-----------------------------------------|---------|----------|-----------------|------------------|----------------|------------------------------------------|--------------|-----------------------|--------------------------|---------|---|----------------------------------------------------------------------|---------|----|----------------------------------------------------------------------------------------------------------------|---------|------------|----------|---|---|---|---|---|---|---|---|---|---|---|---|---|---|---|---|---|---|---|---|
| | | | STANDARDOWE AKCESORIA MOTOCYKLOWE | | | | | | | | | | | | | | | | | | | | | | | | | | | | | | | | | | | | | | | | | | | | | | | | | |
|  <p>BIKE MONOLEVER KIT 19 Dodatkowy moduł do zestawu BIKE UPGRADE KIT do kół motocyklowych z monoleverem.</p> <table border="1"> <tr> <td>1</td> <td>TULEJA CENTRUJĄCA DUCATI/TRIUMPH</td> <td>3-03397</td> </tr> <tr> <td>2</td> <td>TULEJA CENTRUJĄCA MV AGUSTA/HONDA</td> <td>3-03398</td> </tr> <tr> <td>3</td> <td>TULEJA CENTRUJĄCA HONDA GL 1800 / NTV 650</td> <td>3-03399</td> </tr> <tr> <td>4</td> <td>TULEJA CENTRUJĄCA APRILIA/BMW/YAMAHA</td> <td>3-03400</td> </tr> <tr> <td>5</td> <td>TULEJA CENTRUJĄCA TRIUMPH/HONDA VFR1200</td> <td>3-03401</td> </tr> <tr> <td>6</td> <td>CZĘŚĆ CIŚNIENIA</td> <td>3-03402</td> </tr> <tr> <td>7</td> <td>FLANSZA CENTRUJĄCA KTM SUPERDUKE+TRIUMPH</td> <td>3-03403</td> </tr> <tr> <td>8</td> <td>TULEJA DYSTANSOWA, DŁUGA</td> <td>3-03404</td> </tr> <tr> <td>9</td> <td>TARCZA CENTRUJĄCA BMW II (OD ROKU PRODUKCJI 2005) RÓWNIEŻ R V1200 GS</td> <td>3-03405</td> </tr> <tr> <td>10</td> <td>TARCZA CENTRUJĄCA BMW I (OD ROKU PRODUKCJI 2005) APART R V1200 GS, MOTO GUZZI (OD 2008 ROKU) (Ø WEWNĘTRZNA 14)</td> <td>3-03406</td> </tr> </table> | 1 | TULEJA CENTRUJĄCA DUCATI/TRIUMPH | 3-03397 | 2 | TULEJA CENTRUJĄCA MV AGUSTA/HONDA | 3-03398 | 3 | TULEJA CENTRUJĄCA HONDA GL 1800 / NTV 650 | 3-03399 | 4 | TULEJA CENTRUJĄCA APRILIA/BMW/YAMAHA | 3-03400 | 5 | TULEJA CENTRUJĄCA TRIUMPH/HONDA VFR1200 | 3-03401 | 6 | CZĘŚĆ CIŚNIENIA | 3-03402 | 7 | FLANSZA CENTRUJĄCA KTM SUPERDUKE+TRIUMPH | 3-03403 | 8 | TULEJA DYSTANSOWA, DŁUGA | 3-03404 | 9 | TARCZA CENTRUJĄCA BMW II (OD ROKU PRODUKCJI 2005) RÓWNIEŻ R V1200 GS | 3-03405 | 10 | TARCZA CENTRUJĄCA BMW I (OD ROKU PRODUKCJI 2005) APART R V1200 GS, MOTO GUZZI (OD 2008 ROKU) (Ø WEWNĘTRZNA 14) | 3-03406 | 8-21120014 | 3 887,00 | ○ | ○ | ○ | ○ | ○ | ○ | ○ | ○ | ○ | ○ | ○ | ○ | ○ | ○ | ○ | ○ | ○ | ○ | ○ | ○ |
| | 1 | TULEJA CENTRUJĄCA DUCATI/TRIUMPH | 3-03397 | | | | | | | | | | | | | | | | | | | | | | | | | | | | | | | | | | | | | | | | | | | | | | | | | |
| | 2 | TULEJA CENTRUJĄCA MV AGUSTA/HONDA | 3-03398 | | | | | | | | | | | | | | | | | | | | | | | | | | | | | | | | | | | | | | | | | | | | | | | | | |
| | 3 | TULEJA CENTRUJĄCA HONDA GL 1800 / NTV 650 | 3-03399 | | | | | | | | | | | | | | | | | | | | | | | | | | | | | | | | | | | | | | | | | | | | | | | | | |
| | 4 | TULEJA CENTRUJĄCA APRILIA/BMW/YAMAHA | 3-03400 | | | | | | | | | | | | | | | | | | | | | | | | | | | | | | | | | | | | | | | | | | | | | | | | | |
| | 5 | TULEJA CENTRUJĄCA TRIUMPH/HONDA VFR1200 | 3-03401 | | | | | | | | | | | | | | | | | | | | | | | | | | | | | | | | | | | | | | | | | | | | | | | | | |
| | 6 | CZĘŚĆ CIŚNIENIA | 3-03402 | | | | | | | | | | | | | | | | | | | | | | | | | | | | | | | | | | | | | | | | | | | | | | | | | |
| | 7 | FLANSZA CENTRUJĄCA KTM SUPERDUKE+TRIUMPH | 3-03403 | | | | | | | | | | | | | | | | | | | | | | | | | | | | | | | | | | | | | | | | | | | | | | | | | |
| | 8 | TULEJA DYSTANSOWA, DŁUGA | 3-03404 | | | | | | | | | | | | | | | | | | | | | | | | | | | | | | | | | | | | | | | | | | | | | | | | | |
| | 9 | TARCZA CENTRUJĄCA BMW II (OD ROKU PRODUKCJI 2005) RÓWNIEŻ R V1200 GS | 3-03405 | | | | | | | | | | | | | | | | | | | | | | | | | | | | | | | | | | | | | | | | | | | | | | | | | |
| | 10 | TARCZA CENTRUJĄCA BMW I (OD ROKU PRODUKCJI 2005) APART R V1200 GS, MOTO GUZZI (OD 2008 ROKU) (Ø WEWNĘTRZNA 14) | 3-03406 | | | | | | | | | | | | | | | | | | | | | | | | | | | | | | | | | | | | | | | | | | | | | | | | | |
|  <p>Ø14mm Wałek centrujący extra-długi 318mm, do ewentualnego uzupełnienia kodu 8-21120012</p> | 8-21120016 | 1 512,00 | ○ | ○ | ○ | ○ | ○ | ○ | ○ | ○ | ○ | ○ | ○ | ○ | ○ | ○ | ○ | ○ | ○ | ○ | ○ | ○ | | | | | | | | | | | | | | | | | | | | | | | | | | | | | | |
|  <p>Ø19mm Wałek centrujący extra-długi 365mm, do ewentualnego uzupełnienia kodu 8-21120013</p> | 8-21120017 | 1 647,00 | ○ | ○ | ○ | ○ | ○ | ○ | ○ | ○ | ○ | ○ | ○ | ○ | ○ | ○ | ○ | ○ | ○ | ○ | ○ | ○ | | | | | | | | | | | | | | | | | | | | | | | | | | | | | | |

■ = Standard ○ = Kompatybilne - = NIEkompatybilne



www.corgi.pl

EM 9050 SPACESAVER



STANDARDOWE AKCESORIA



Ø 42÷103,5 mm



x3



DLA WERSJI
HAND SPIN



DLA WERSJI Z
NAPEDEM



| Kod | Zasilanie | Opis | Cena netto |
|---------------|----------------------|-----------------------------------------------------------------------------------------------------------------------------------------------------------------------------------------------------------------------------------------------------------------------------------------------------------------------------------------------------------------|------------|
| 0-21109051/16 | 200-230V/1Ph/50-60Hz | EM 9050 SPACESAVER - HAND SPIN Przenośna wyważarka do opon samochodowych o niewielkich wymiarach i wadze; specjalnie zaprojektowane do obsługi mobilnej i warsztatów o ograniczonej przestrzeni roboczej. Ręczna wersja. Automatyczne wykrywanie rozmiaru kół SmartArm 28". Hamulec obsługiwany dźwignią. | 11 650,00 |
| 0-21109050/16 | 200-230V/1Ph/50-60Hz | EM 9050 SPACESAVER - MOTORIZED Przenośna wyważarka do opon samochodowych, kompaktowa pod względem wymiarów i wagi; specjalnie zaprojektowane do obsługi mobilnej i warsztatów o ograniczonej przestrzeni roboczej. Wersja z napędem elektrycznym uruchamiana dźwignią. Automatyczne wykrywanie rozmiarów kół SmartArm 28". Hamulec obsługiwany dźwignią. | 12 995,00 |

ODLICZ OD CENY -20 % RABATU

EM 9050 - TILT UP - HAND SPIN



STANDARDOWE AKCESORIA



| Kod | Zasilanie | Opis | Cena netto |
|---------------|----------------------|---------------------------------------------------------------------------------------------------------------------------------------------------------------------------------------------------------------------------------------------------------------------------------------------------------|------------------|
| 0-21109052/16 | 200-230V/1Ph/50-60Hz | EM9050 SPACESAVER - TILT UP - HAND SPIN Specjalna wersja do obsługi mobilnej. Idealny do pracy wewnątrz furgonetki dzięki możliwości odchylenia jednostki pomiarowej do pozycji pionowej. Wersja z ręcznym obrotem, automatyczne wykrywanie rozmiaru kół SmartArm. Hamulec obsługiwany dźwignią. | 12 995,00 |

ODLICZ OD CENY -20 % RABATU

EM 9050 - SLIDE - Motorized Spin



STANDARDOWE AKCESORIA

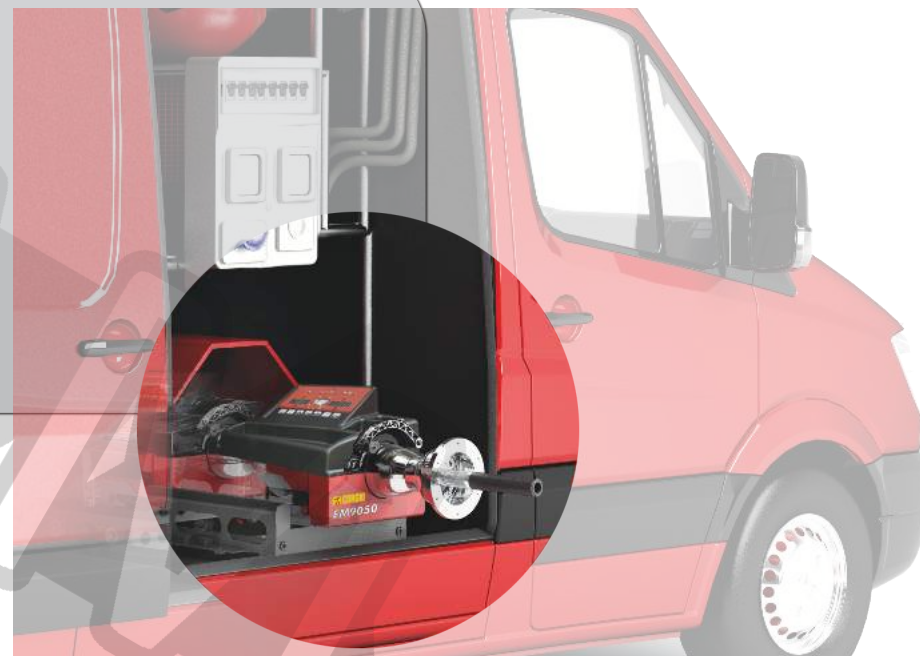

| Kod | Zasilanie | Opis | Cena netto |
|---------------|-----------------------------------|-----------------------------------------------------------------------------------------------------------------------------------------------------------------------------------------------------------------------------------------------------------------------------------------------|------------------|
| 0-21109053/16 | 200-230V/1P _H /50-60Hz | EM 9050 SPACESAVER - SLIDE - MOTORIZED Specjalna wersja do obsługi mobilnej. Można go wyjąć z bocznych drzwi i umożliwia wygodną pracę poza furgonetką. Wersja z napędem silnikowym uruchamiana dźwignią, automatyczne wykrywanie rozmiaru kół SmartArm. Hamulec obsługiwany dźwignią. | 15 342,00 |

ODLICZ OD CENY -20% RABATU

EM 9050 WORKBENCH



STANDARDOWE AKCESORIA



DLA WERSJI
HAND SPIN

Ø 42÷103,5 mm

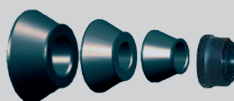

x3

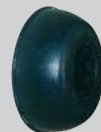

DLA WERSJI Z
NAPĘDEM







| Kod | Zasilanie | Opis | Cena netto |
|---------------|----------------------------------|------------------------------------------------------------------------------------------------------------------------------------------------------------------------------------------------------------------------------------------------------------------------------------------------------------------------|------------|
| 0-21109057/16 | 100÷230/1P _H /50-60Hz | EM9050 WORKBENCH - Hand Spin. Niezwykle kompaktowa wyważarka do kół. Można ją przymocować do stołu warsztatowego. Dla hobbystów, małych warsztatów lub do serwisu mobilnego. Automatyczne wykrywanie rozmiaru koła SmartArm 28". Hamulec sterowany dźwignią. Wersja ręczna. | 11 203,00 |
| 0-21109056/16 | 200÷230/1P _H /50-60Hz | EM9050 WORKBENCH - Motorized Spin. Niezwykle kompaktowa wyważarka do kół. Można ją przymocować do stołu warsztatowego. Dla hobbystów, małych warsztatów lub serwisu mobilnego. Automatyczne wykrywanie rozmiaru koła SmartArm 28". Hamulec sterowany dźwignią. Wersja z napędem silnikowym uruchamiana dźwignią | 12 445,00 |

ODLICZ OD CENY -20% RABATU

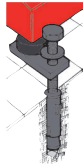

ZALECANE AKCESORIA DO SERWISU MOBILNEGO

| | Opis | Kod | Cena netto | EM 9050 HS | EM 9050 Motor | EM 9050 Tilt | EM 9050 Slide | EM 9050 WB HS | EM 9050 WB Motor |
|-------------------------------------------------------------------------------------|--------------------------------------------------------------------------------------------------------------------------------------------------------------------|----------------------|-----------------|------------|---------------|--------------|---------------|---------------|------------------|
|  | PL - idealna stopa do montażu bez kotwienia do podłoża; dostępny w kolorze czerwonym (/16) i szarym (/90) (nie dotyczy wersji EM9050 SLIDE) | 8-21101100/XX | 420,00 | O | O | O | - | - | - |
|  | Wózek ułatwiający obsługę (nie dotyczy wersji EM9050 SLIDE) | 8-21101200 | 284,00 | O | O | O | - | - | - |
|  | AL12 - zestaw zasilacza 12v (tylko dla wersji EM9050 Hand Spin) | 8-21101000 | 396,00 | O | - | O | - | O | - |
|  | Zestaw TILT do uzyskania wersji TILT; Idealny do pracy wewnątrz samochodu dostawczego dzięki możliwości pochylenia jednostki pomiarowej do pozycji pionowej | 8-21101300 | 1 375,00 | O | O | - | - | - | - |
|  | Zestaw KFTU — zestaw do mocowania do podłogi (dostarczany już z EM9050 Hand Spin, EM 9050 Motorized Spin, EM 9050 TILT UP) | 8-21101010 | 246,00 | ■ | ■ | ■ | - | - | - |

■ = Standard O = Kompatybilne - = NIEkompatybilne

ZALECANE AKCESORIA DO SERWISU MOBILNEGO

| | Opis | Kod | Cena netto | EM 9050 HS | EM 9050 Motor | EM 9050 Tilt | EM 9050 Slide | EM 9050 WB HS | EM 9050 WB Motor | | | | | | | | | | | | | | | | | | |
|-------------------------------------------------------------------------------------|--------------------------------------------------------------------------------------------------------------------------------------------------------------------------------------------------------------------------------------------------------------------------------------------------------------------------------------------------------------------------------------------------------------------------------------------------------------------------------------------------------------------------------------------------------------------------------------------------------------------------------------------------------------------------------------------------------------------------------------------------------------------------------------------------------------------------------------------------------------------------------------------------------------------------------------------------------------------------------------------------------------------------------------------------------------------------------------------------------------------------------|-------------------|--------------------------------------------------------------------------------------------------------------------|------------|---------------|------------------------------------------------------------------------------------------------------|---------------|---------------|-----------------------------------------------|----------|-------------------|--------------------|----------|-----------|--------------------------------------------------------------------------------------------------------------------------------------------------------------------------------|----------|-----------|-----------------------------------------------------------------------------------------------------------------|----------|-------------------|-----------------|---|---|---|---|---|---|
|  | ARF Akcesorium do kół terenowych Ø 102,5÷118,5 mm. | 8-21100080 | 500,00 | O | O | O | O | O | O | | | | | | | | | | | | | | | | | | |
|  | MLC Obrót uchwyty do flanszy FRU-SA | 802244344 | 170,00 | O | - | O | - | O | - | | | | | | | | | | | | | | | | | | |
|  | DX/CBF Akcesorium centrujące do samochodów dostawczych i terenowych Ø 117÷173 mm. <table border="1" style="width: 100%; border-collapse: collapse;"> <tr> <td style="width: 10%;">DX1</td> <td style="width: 60%;">Nasadka dystansowa</td> <td style="width: 30%;">4-107426</td> </tr> <tr> <td>CF1</td> <td>Stożek do samochodów dostawczych ø 117÷147 mm</td> <td>4-107423</td> </tr> <tr> <td>CF2</td> <td>Stożek do samochodów dostawczych ø 143÷173 mm</td> <td>4-107424</td> </tr> </table> | DX1 | Nasadka dystansowa | 4-107426 | CF1 | Stożek do samochodów dostawczych ø 117÷147 mm | 4-107423 | CF2 | Stożek do samochodów dostawczych ø 143÷173 mm | 4-107424 | 8-21100141 | 1 620,00 | O | O | O | O | O | O | | | | | | | | | |
| DX1 | Nasadka dystansowa | 4-107426 | | | | | | | | | | | | | | | | | | | | | | | | | |
| CF1 | Stożek do samochodów dostawczych ø 117÷147 mm | 4-107423 | | | | | | | | | | | | | | | | | | | | | | | | | |
| CF2 | Stożek do samochodów dostawczych ø 143÷173 mm | 4-107424 | | | | | | | | | | | | | | | | | | | | | | | | | |
|  | SBC Zestaw sześciu tulei centrujących ø 40 mm. <table border="1" style="width: 100%; border-collapse: collapse;"> <tr> <td style="width: 10%;">B1</td> <td style="width: 60%;">AUDI, BMW, Chrysler, Opel, Rover, Seat, VW, Daewoo, Galaxy (Ford), Lotus, British-Leyland, Smart (Mercedes), Skoda</td> <td style="width: 30%;">4-105075</td> </tr> <tr> <td>B2</td> <td>Citröen, Hyundai, Lancia, Maserati, Mazda, Mercedes, Mitsubishi, Nissan, Opel, Peugeot, Saab, Volvo.</td> <td>4-105076</td> </tr> <tr> <td>B3</td> <td>BMW, Jaguar, Aston Martin.</td> <td>4-105077</td> </tr> <tr> <td>B4</td> <td>Ford, Honda, Rover</td> <td>4-105078</td> </tr> <tr> <td>B5</td> <td>Autobianchi, Alfa Romeo, Citröen, Fiat, Lada, Lancia, Jalbot, Biturbo (Maserati), Mazda, Nissan, Peugeot, Porsche, Renault, 2600-3500 serie (Rover), Seat =>90, Skoda, Toyota.</td> <td>4-105079</td> </tr> <tr> <td>B7</td> <td>Citröen, Daihatsu, Honda, Kia, Mazda, Mitsubishi, Peugeot, Rover, Subaru, Toyota, Agila (Opel), Suzuki, Hyuday.</td> <td>4-105080</td> </tr> </table> | B1 | AUDI, BMW, Chrysler, Opel, Rover, Seat, VW, Daewoo, Galaxy (Ford), Lotus, British-Leyland, Smart (Mercedes), Skoda | 4-105075 | B2 | Citröen, Hyundai, Lancia, Maserati, Mazda, Mercedes, Mitsubishi, Nissan, Opel, Peugeot, Saab, Volvo. | 4-105076 | B3 | BMW, Jaguar, Aston Martin. | 4-105077 | B4 | Ford, Honda, Rover | 4-105078 | B5 | Autobianchi, Alfa Romeo, Citröen, Fiat, Lada, Lancia, Jalbot, Biturbo (Maserati), Mazda, Nissan, Peugeot, Porsche, Renault, 2600-3500 serie (Rover), Seat =>90, Skoda, Toyota. | 4-105079 | B7 | Citröen, Daihatsu, Honda, Kia, Mazda, Mitsubishi, Peugeot, Rover, Subaru, Toyota, Agila (Opel), Suzuki, Hyuday. | 4-105080 | 8-21100082 | 1 243,00 | O | O | O | O | O | O |
| B1 | AUDI, BMW, Chrysler, Opel, Rover, Seat, VW, Daewoo, Galaxy (Ford), Lotus, British-Leyland, Smart (Mercedes), Skoda | 4-105075 | | | | | | | | | | | | | | | | | | | | | | | | | |
| B2 | Citröen, Hyundai, Lancia, Maserati, Mazda, Mercedes, Mitsubishi, Nissan, Opel, Peugeot, Saab, Volvo. | 4-105076 | | | | | | | | | | | | | | | | | | | | | | | | | |
| B3 | BMW, Jaguar, Aston Martin. | 4-105077 | | | | | | | | | | | | | | | | | | | | | | | | | |
| B4 | Ford, Honda, Rover | 4-105078 | | | | | | | | | | | | | | | | | | | | | | | | | |
| B5 | Autobianchi, Alfa Romeo, Citröen, Fiat, Lada, Lancia, Jalbot, Biturbo (Maserati), Mazda, Nissan, Peugeot, Porsche, Renault, 2600-3500 serie (Rover), Seat =>90, Skoda, Toyota. | 4-105079 | | | | | | | | | | | | | | | | | | | | | | | | | |
| B7 | Citröen, Daihatsu, Honda, Kia, Mazda, Mitsubishi, Peugeot, Rover, Subaru, Toyota, Agila (Opel), Suzuki, Hyuday. | 4-105080 | | | | | | | | | | | | | | | | | | | | | | | | | |
|  | VGBP Uchwyt do nakrętki koła | 802260682 | 429,00 | O | ■ | O | ■ | O | ■ | | | | | | | | | | | | | | | | | | |

■ = Standard O = Kompatybilne - = NIEkompatybilne

ZALECANE AKCESORIA DO SERWISU MOBILNEGO

| | Opis | Kod | Cena netto | EM 9050 HS | EM 9050 Motor | EM 9050 Tilt | EM 9050 Slide | EM 9050 WB HS | EM 9050 WB Motor |
|-----------------------------------------------------------------------------------|----------------------------------------------------------------------------------------------------------------------------------------------------------------------------------------------------------------|------------|------------|------------|---------------|--------------|---------------|---------------|------------------|
|  | WYKRYWANIE ROZMIARÓW KOŁA cyfrowy miernik do pozyskiwania średnicy i odległości. Maksymalna precyzja przy wykorzystaniu systemu FSP, który automatycznie dobiera odpowiedni program wyważania. | 8-21120022 | 975,00 | 0 | 0 | 0 | 0 | 0 | 0 |

SAM
INWEST

■ = Standard

○ = Kompatybilne

- = NIEkompatybilne



www.corgi.pl



SAMINWEST
ul. Rybnicka 77a, 44-285 Rzuchów
tel.: 32-430-10-62
saminwest@saminwest.com
www.corghi.pl

PIERWSZY AUTORYZOWANY PRZEDSTAWICIEL MARKI CORGHI NIEPRZERWANIE OD 30LAT

