



**SAM**  
inwest



# WYWAŻARKI DO KÓŁ OSOBOWYCH

**CENNIK 07.2024**



**PIERWSZY AUTORYZOWANY DYSTRYBUTOR I  
PRZEDSTAWICIEL MARKI CORGHI W POLSCE**

Wersja  
PL

## O MARCE

CORGHI (1954) jest największym producentem sprzętu do obsługi kół. Obecna gama oferowanych produktów zawiera montażownice automatyczne, wyważarki do kół, urządzenia do ustawiania geometrii kół, podnośniki, linie diagnostyczne, inny sprzęt diagnostyczny oraz urządzenia dodatkowe. Wraz z partnerami, Corghi posiada największą na świecie sieć dystrybucji sprzętu do obsługi samochodów. Swoim zasięgiem obejmuje 137 krajów, posiada ponadto swe filie w Niemczech, Meksyku i Chinach, a w 2009 roku została otwarta filia w Stanach Zjednoczonych. Od roku 2018 zmieniono nazwę firmy na Nexion SPA. Marka Corghi i siedziba pozostała bez zmian.

## MISJA FIRMY

Klienci są najważniejsi – naszym najważniejszym priorytetem jest zadowolenie klienta z jakości, dystrybucji i innowacyjności produktów.

Całościowe i kompleksowe rozwiązania we wszystkim co robimy – jest kluczem do budowania silnych relacji partnerskich ze współpracownikami, klientami, dostawcami a naszą firmą.

Ciągłe udoskonalanie – jest bardzo ważnym aspektem naszej działalności.

Innowacyjność dla rozwoju – kreatywne i całościowe rozwiązania prowadzą nas do rozwoju.

Najlepsze talenty dla zespołu – nasza kadra jest wysoko wykwalifikowana, kreatywna, przedsiębiorcza i wie jak osiągnąć najlepsze efekty.

## INNOWACYJNOŚĆ

Corghi może także poszczycić się nagrodami za innowacyjność technologiczną w swoim sektorze, przyznanymi przez niezależne organizacje certyfikujące i doceniające ciągle starania i wysiłki w osiągnięciu rezultatów w innowacyjności. Innowacyjności, która pozwala specjalistom z branży oponiarskiej oraz branży automechaniki na pełny profesjonalizm w swej dziedzinie w odpowiedzi na wszelkie nowinki techniczne związane z projektowaniem samochodów i opon.

## CENNIK

Producent zastrzega sobie prawo do zmiany parametrów swoich produktów w dowolnym czasie. Informacje zawarte w niniejszym cenniku nie są prawnie wiążące i nie stanowią oferty handlowej, w tym w rozumieniu art. 66 § 1 Kodeksu cywilnego. Zdjęcia mają charakter poglądowy i mogą różnić się od oryginału. Zastrzegamy sobie prawo do zmian cen sprzedaży w przypadku, gdy wartość kursu sprzedaży EUR w NBP przekroczy 5,1000 PLN/€. Kopiowanie oraz jakiegokolwiek modyfikowane zabronione. Cennik ważny od 10.07.2024 aż do ukazania się nowej wersji.

*Gwarantujemy najlepsze ceny Marki  
CORGHI w kraju. Wysokie rabaty  
dla każdego klienta na maszyny  
najwyższej jakości.  
Znajdź lepszą ofertę na  
rynku a sprostamy każdej*

*Ceny podane w niniejszym cenniku są  
cenami katalogowymi netto bez rabatu. Standardowy  
rabat to **-15%** odliczany od cen katalogowych netto.*

*Skontaktuj się z nami aby otrzymać coś  
więcej i dowiedzieć się o naszych promocjach*

**Tel. 601 555 541**



# Wyjaśnienia ikon i opisy funkcji do nich przypisanych



## 1 SYSTEM OSZCZĘDZANIA CIĘŻARKÓW

Jest to oprogramowanie zawierające system oszczędzania ciężarków minimalizujący czas pracy i ilość aplikowanych ciężarków zmniejszając koszty i zagrożenie dla środowiska.



## 2 EKRAN DOTYKOWY

Graficzny interfejs, oraz dotykowa technologia ułatwiają i przyspieszają pracę i wybór programów.



## 3 WSKAŹNIK APLIKOWANIA CIĘŻARKÓW

Ciężarki klejone mogą być łatwo aplikowane w miejscu wskazanym przez wskaźnik laserowy.



## 4 AUTOMATYCZNE MOCOWANIE KOŁA

Nowy elektromechaniczny system mocowania skracający czas i zwiększający precyzję centrowania koła.



## 5 INTELIGENTNE POZYCJONOWANIE

Specjalne narzędzie diagnostyczne. Po zbadaniu wszystkich kół pojazdu pod kątem zużycia bieżnika, starcia kierunkowego czy niedowagi system proponuje odpowiednie rozłożenie kół na pojeździe zwiększające komfort i bezpieczeństwo jazdy. Test drogowy bez testu obciążeniowego.



## 6 OŚWIETLENIE LED

Ułatwia pracę przy czyszczeniu miejsca aplikacji ciężarka i procesu klejenia.



## 7 KOMPLETNA DIAGNOSTYKA KOŁA

Diagnostyczny program automatycznie mierzy następujące parametry za pomocą sonaru:

- precyzyjny pomiar bicia koła we wszystkich płaszczyznach oraz kalkulacja optymalnego spasowania felga-opona, rozwiązujący większość problemów wibracji powodowanych ogumieniem.
- ścięcie opony, który powoduje że pojazd jest stale ciągnięty w jedną stronę w czasie jazdy w linii prostej
- głębokość bieżnika.



## 8 OSZCZĘDNOŚĆ MIEJSCA

Pochylny przód maszyny dla łatwiejszego dostępu do wnętrza koła, oraz osłona koła zaprojektowana tak, aby zminimalizować potrzebne miejsce, tzw. „Zero Space”.



## 9 PRZYCISK WIELOFUNKCYJNY I STÓŁ NA CIĘŻARKI

Stół na ciężarki jest ergonomiczny i funkcjonalny, może pomieścić różne rodzaje ciężarków oraz narzędzi. Przycisk wielofunkcyjny jest prosty i szybki oraz ułatwia wybór programów.



## 10 W PEŁNI AUTOMATYCZNA

Nie wymaga żadnych operacji ręcznych od operatora.



## 11 TRYB UKRYTEGO CIĘŻARU

Nowy program ukrytego ciężaru tzw. "Hidden Weight" do podziału ciężarków na dwie równoważne wagi ukryte za szprychami. Całkowicie automatyczna operacja.



## 12 WYKRYWANIE WYMIARÓW KÓŁ

cyfrowy miernik do akwizycji średnicy i odległości z funkcją FSP (Fast Selection Program) i nowym zintegrowanym wskaźnikiem LaserBlade: funkcja FSP automatycznie aktywuje program wyważania, unikając wyboru za pomocą klawiatury, podczas gdy wskaźnik LaserBlade (wewnątrz ramienia pomiarowego) bezbłędnie i przy wyjątkowo dobrej widoczności pomaga operatorowi w wyborze poziomu w aluminiowej feldze.



## 13 AUTOMATYCZNY POMIAR SZEROKOŚCI KOŁA

Automatyczny czujnik AWD (Auto width Device) do bezdotykowego pomiaru szerokości koła (opcjonalny)



## 14 PNEUMATYCZNE MOCOWANIE KOŁA

Pneumatyczny system mocowania koła za pomocą pedału.



## 15 AUTOMATYCZNE POZYCJONOWANIE

Automatyczne zatrzymanie koła następuje w punkcie, gdzie wyważony ciężar jest pozycjonowany (RPA) oraz stosowany jest elektryczny hamulec

# SPIS TREŚCI

*Kliknij na produkt, lub stronę, aby się na nią przenieść.*

## WYWAŻARKI DO SAMOCHODÓW OSOBOWYCH/VAN/BUS

<a href="#">EYE-LIGHT PLUS DIAGNOSTICLINE</a>	<a href="#">6</a>
<a href="#">EM 9980C PLUS DIAGNOSTICLINE</a>	<a href="#">7</a>
<a href="#">EM 9780C PLUS AUTOMATICLINE</a>	<a href="#">8</a>
<a href="#">EM 9580 C PLUS TOUCHSCREEN</a>	<a href="#">9</a>
<a href="#">EM 9580 PLUS TOUCHSCREEN</a>	<a href="#">10</a>
<a href="#">EM 9580 C PLUS LASERLINE</a>	<a href="#">11</a>
<a href="#">EM 9580 PLUS LASERLINE</a>	<a href="#">12</a>
<a href="#">EM 9550 C PLUS LASERLINE</a>	<a href="#">13</a>
<a href="#">EM 9550 PLUS LASERLINE</a>	<a href="#">14</a>
<a href="#">EM 9380 C XLINE TOUCHSCREEN</a>	<a href="#">15</a>
<a href="#">EM 9380 C XLINE</a>	<a href="#">15</a>
<a href="#">EM 9380 XLINE TOUCHSCREEN</a>	<a href="#">16</a>
<a href="#">EM 9380 XLINE</a>	<a href="#">16</a>
<a href="#">EM 9350 C XLINE</a>	<a href="#">17</a>
<a href="#">EM 9350 XLINE</a>	<a href="#">18</a>
<a href="#">EM 9280 C COMPACTLINE</a>	<a href="#">19</a>
<a href="#">EM 9280 COMPACTLINE</a>	<a href="#">20</a>
<a href="#">EM 9250 COMPACTLINE</a>	<a href="#">21</a>

## WYWAŻARKI DO MOTOCYKLI

<a href="#">EM 9250 BASIC BIKELINE</a>	<a href="#">22</a>
--	--------------------

<b>AKCESORIA DLA WYWAŻAREK SAMOCHODOWYCH I DO MOTOCYKLI</b>	<b>24</b>
---	-----------

## WYWAŻARKI DO MOBILNYCH SERWISÓW SAMOCHODOWYCH

<a href="#">EM 9050 SPACESAVER</a>	<a href="#">50</a>
<a href="#">EM 9050 - TILT-UP - HAND SPIN</a>	<a href="#">51</a>
<a href="#">EM 9050 - SLIDE - MOTORIZED SPIN</a>	<a href="#">52</a>
<a href="#">EM 9050 - WORKBENCH - HAND SPIN</a>	<a href="#">53</a>
<a href="#">EM 9050 - WORKBENCH - MOTORIZED SPIN</a>	<a href="#">53</a>

<b>REKOMENDOWANE AKCESORIA DLA MOBILNYCH SERWISÓW SAMOCHODOWYCH</b>	<b>54</b>
---	-----------

# WYWAŻARKI DO SAMOCHODÓW OSOBOWYCH/VAN/BUS

## EYE-LIGHT PLUS DIAGNOSTICLINE



### STANDARDOWE AKCESORIA

Kod 8-21100221

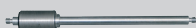

Kod  
802227308



Kod  
8-21100142

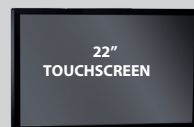

Kod 5-120500A

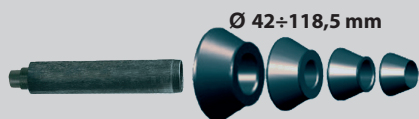

x3



dla wersji Winut



Wersja Winut



Kod	Zasilanie	Opis	Cena netto
0-21101101/16	100-230V / 1P <sub>H</sub> / 50-60Hz	<b>Eye-Light Plus DiagnosticLine WiNUT</b> Diagnostyczna wyważarka z dotykowym monitorem LCD, przemysłowym komputerem klasy PC, kamerą, systemem WM, automatyczną osłoną koła, bezkontaktowym systemem pobierania danych za pomocą lasera, systemem iPos - system optymalizacji do najlepszego pozycjonowania kół na pojeździe oraz automatycznym bezprzewodowym mocowaniem koła (WiNUT), panel na tulejki HPC, zestaw tulejek HPC. Diagnostyka koła, lub obręczy przy pomocy precyzyjnych promieni laserowych: a) precyzyjny pomiar bicia koła we wszystkich płaszczyznach (bicie promieniowe i boczne) oraz kalkulacja optymalnego spasowania felga-opona, rozwiązujący większość problemów wibracji powodowanych ogumieniem, b) ścięcie opony, który powoduje że pojazd jest stale ciągnięty w jedną stronę w czasie jazdy w linii prostej, c) głębokość bieżnika w 3 miejscach	78 863,00
0-21101100/16	100-230V / 1P <sub>H</sub> / 50-60Hz	Jak wyżej, ale z automatyczną blokadą kół sterowaną pedałem	76 167,00



www.corghi.pl

**ODLICZ OD CENY -15 % RABATU**

Cennik SAMINWEST ważny od 10.07.2024 do ukazania się nowej wersji.

# WYWAŻARKI DO SAMOCHODÓW OSOBOWYCH/VAN/BUS

## EM 9980C PLUS DIAGNOSTICLINE



Kod  
8-21100221



dla wersji Winut



Kod  
802227308



### STANDARDOWE AKCESORIA



Kod  
5-120500A

Kod  
8-21100142



32"



Wersja Winut



Kod	Zasilanie	Opis	Cena netto
0-21109984/16	100-230V / 1P <sub>H</sub> / 50-60Hz	<b>EM 9980C PLUS DiagnosticLine WiNUT</b> Diagnostyczna wyważarka z dotykowym monitorem LCD, systemem WM, bezkontaktowym systemem pobierania danych za pomocą lasera, systemem iPos- system optymalizacji do najlepszego pozycjonowania kół na pojeździe oraz automatycznym bezprzewodowym mocowaniem koła (WiNUT). Diagnostyka koła, lub obręczy przy pomocy precyzyjnych promieni laserowych: precyzyjny pomiar bicia koła we wszystkich płaszczyznach (bicie promieniowe i boczne) oraz kalkulacja optymalnego spasowania felga-opona, rozwiązujący większość problemów wibracji powodowanych ogumieniem	57 477,00
0-21109983/16	100-230V / 1P <sub>H</sub> / 50-60Hz	Jak wyżej, ale z automatyczną blokadą kół sterowaną pedałem	54 833,00

**ODLICZ OD CENY -15 % RABATU**



www.corgi.pl

# WYWAŻARKI DO SAMOCHODÓW OSOBOWYCH/VAN/BUS

## EM 9780C PLUS AUTOMATICLINE



### STANDARDOWE AKCESORIA

Kod  
8-21100221

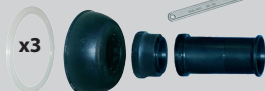
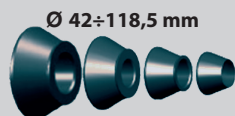

Kod  
5-120500A

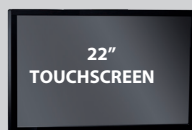

Kod  
8-21100142



dla wersji Winut



Kod  
802227308



Kod	Zasilanie	Opis	Cena netto
0-21109784/16	100-230V / 1P <sub>H</sub> / 50-60Hz	<b>EM 9780C PLUS AutomaticLine WiNUT</b> Wyważarka z dotykowym monitorem LCD, bezkontaktowym systemem wprowadzania danych koła (połączenie lasera i sonaru AWD(standard)), systemem oszczędzania ciężarków (WM), systemem iPos- system optymalizacji do najlepszego pozycjonowania kół na pojeździe oraz automatycznym bezprzewodowym mocowaniem koła (WiNUT).	47 192,00
0-21109783/16	100-230V / 1P <sub>H</sub> / 50-60Hz	Jak wyżej, ale z automatyczną blokadą kół sterowaną pedałem	44 548,00
8-21100250	-	<b>Sonar diagnostyczny</b> ( opcja ) precyzyjny pomiar bicia koła we wszystkich płaszczyznach (bicie promieniowe i boczne) oraz kalkulacja optymalnego spasowania felgaopona, rozwiązujący większość problemów wibracji powodowanych ogumieniem	+ 2 574,00

Polecane

**ODLICZ OD CENY -15 % RABATU**



www.corghi.pl



# WYWAŻARKI DO SAMOCHODÓW OSOBOWYCH/VAN/BUS

## EM 9580 C Plus TOUCHSCREEN



### STANDARDOWE AKCESORIA

Kod  
8-11100221

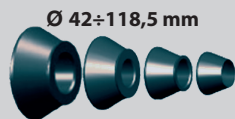

Ø 42÷118,5 mm



x3

Kod 5-120500A



Kod  
8-21100159



dla wersji Winut

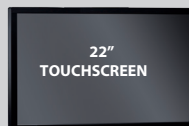

22"  
TOUCHSCREEN

Kod  
802227308



Kod  
8-21100142



Kod	Zasilanie	Opis	Cena netto
0-21109592/16	100-230V / 1P <sub>H</sub> / 50-60Hz	<b>EM 9580C PLUS TouchScreen</b> Wyważarka z bezprzewodowym systemem szybkoocucującym (WiNUT) z 22-calowym monitorem dotykowym, wskaźnikiem LaserLine (2 lasery), oświetleniem LED. Tradycyjne ramię do wprowadzania danych z 28-calowym urządzeniem SmartArm do automatycznego wprowadzania danych z programem szybkiego wyboru FST, funkcją LaserBlade, osłona koła „Zero Space”, program oszczędzania ciężarków WM w zestawie. <b>Zalecamy dokupić opcjonalnie AWD (+ 2 635,00 zł).</b>	<b>39 040,00</b>
0-21109591/16	100-230V / 1P <sub>H</sub> / 50-60Hz	Jak wyżej, ale z automatyczną blokadą kół sterowaną pedałem. <b>Zalecamy dokupić opcjonalnie AWD (+ 2 635,00 zł).</b>	<b>36 396,00</b>
8-21100250	-	<b>Sonar diagnostyczny</b> ( opcja ) umożliwiający precyzyjny pomiar bicia promieniowego koła w jednej płaszczyźnie	<b>+ 2 574,00</b>

Polecane

**ODLICZ OD CENY -15 % RABATU**



www.corgi.pl

# WYWAŻARKI DO SAMOCHODÓW OSOBOWYCH/VAN/BUS

## EM 9580 PLUS TOUCHSCREEN



### STANDARDOWE AKCESORIA

Kod  
8-11100221



Kod  
802227308



Ø 42÷118,5 mm

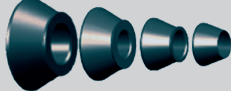

Kod  
8-21100159



Kod  
8-21100142



x3

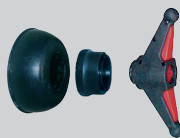

Kod 5-120500A



TOUCHSCREEN



28"



Kod	Zasilanie	Opis	Cena netto
0-21109590/16	100-230V / 1P <sub>H</sub> / 50-60Hz	<b>EM 9580 PLUS TouchScreen</b> Wyważarka do kół z 22-calowym przemysłowym monitorem dotykowym, wskaźnikiem LaserLine, podświetleniem LED, 28-calowym urządzeniem SmartArm do automatycznego wprowadzania danych z programem FST Fast Selection, funkcją LaserBlade, ręcznym mocowaniem koła, osłoną koła „Zero Space”, programem WM. <b>Zalecamy dokupić opcjonalnie AWD (+ 2 635,00 zł).</b>	<b>31 150,00</b>
8-21100250	-	<b>Sonar diagnostyczny</b> ( opcja ) umożliwiający precyzyjny pomiar bicia promieniowego koła w jednej płaszczyźnie	<b>+ 2 574,00</b>

**ODLICZ OD CENY -15 % RABATU**



www.corghi.pl

# WYWAŻARKI DO SAMOCHODÓW OSOBOWYCH/VAN/BUS

## EM 9580 C Plus LASERLINE



### STANDARDOWE AKCESORIA

Kod  
8-11100221



dla wersji Winut

Kod  
802227308



Kod  
8-21100159



Kod  
8-21100142



28"



Kod	Zasilanie	Opis	Cena netto
0-21109588/16	100-230V / 1P <sub>H</sub> / 50-60Hz	<b>EM 9580C PLUS LaserLine WiNUT</b> Wyważarka z bezprzewodowym systemem szybkoocującym (WiNUT) zwiększającym komfort pracy, bez użycia pedału, dwoma wskaźnikami laserowymi, automatycznym dobieraniem odpowiedniego programu wyważania, systemem oszczędzania ciężarków (program WM), monitorem LCD, osłona "Zero space". <b>Zalecamy dokupić opcjonalnie AWD (+ 2 635,00 zł).</b>	<b>35 517,00</b>
0-21109586/16	100-230V / 1P <sub>H</sub> / 50-60Hz	<b>EM 9580C Plus LaserLine</b> to samo co wersja powyżej ale z mocowaniem elektromechanicznym za pomocą pedału. <b>Zalecamy dokupić opcjonalnie AWD (+ 2 635,00 zł).</b>	<b>32 874,00</b>
8-21100250	-	<b>Sonar diagnostyczny</b> ( opcja ) umożliwiający precyzyjny pomiar bicia promieniowego koła w jednej płaszczyźnie	<b>+ 2 574,00</b>

Polecane

**ODLICZ OD CENY -15 % RABATU**



www.corghi.pl

# WYWAŻARKI DO SAMOCHODÓW OSOBOWYCH/VAN/BUS

## EM 9580 PLUS LASERLINE



### STANDARDOWE AKCESORIA

Kod  
8-21100221



Ø 42÷118,5 mm



Kod  
802227308



x3

Kod  
8-21100159

Kod  
8-21100142



28"



Kod	Zasilanie	Opis	Cena netto
0-21109587/16	100-230V / 1P <sub>H</sub> / 50-60Hz	<b>EM 9580 PLUS LaserLine</b> Wyważarka do kół ze wskaźnikiem LaserLine, ręczne mocowanie koła, automatyczne wprowadzanie danych z programem szybkiego wyboru, osłona koła „Zero Space”, w zestawie program WM. <b>Zalecamy dokupić opcjonalnie AWD (+ 2 635,00 zł).</b>	<b>27 680,00</b>
8-21100250	-	<b>Sonar diagnostyczny</b> ( opcja ) umożliwiający precyzyjny pomiar bicia promieniowego koła w jednej płaszczyźnie	<b>+ 2 574,00</b>

**ODLICZ OD CENY -15 % RABATU**

# WYWAŻARKI DO SAMOCHODÓW OSOBOWYCH/VAN/BUS

## EM 9550 C Plus LASERLINE



Kod  
8-21100221

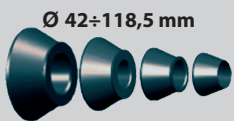

Kod  
802227308



Kod  
8-21100159

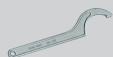

Kod	Zasilanie	Opis	Cena netto
0-21109556/16	100-230V / 1P <sub>H</sub> / 50-60Hz	<b>EM 9550 C Plus LaserLine</b> Wyważarka z elektromechanicznym uchwytem szybkoocującym za pomocą pedału, wyświetlaczem, wskaźnikiem laserowym oraz automatycznym dobieraniem odpowiedniego programu wyważania, osłona "Zero space". <b>Zalecamy dokupić opcjonalnie AWD (+ 2 635,00 zł).</b>	<b>27 259,00</b>

**ODLICZ OD CENY -15 % RABATU**



www.corghi.pl

## EM 9550 PLUS LASERLINE



Kod  
8-21100221



Kod  
802227308



### STANDARDOWE AKCESORIA



x3

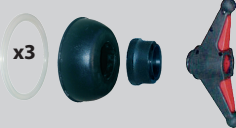

Kod  
8-21100159



Kod	Zasilanie	Opis	Cena netto
0-21109557/16	100-230V / 1P <sub>H</sub> / 50-60Hz	<b>EM 9550 Plus LaserLine</b> Wyważarka z wyświetlaczem, wskaźnikiem laserowym, automatycznym dobieraniem odpowiedniego programu wyważania, osłona "Zero space". <b>Zalecamy dokupić opcjonalnie AWD (+ 2 635,00 zł).</b>	<b>22 178,00</b>

**ODLICZ OD CENY -15 % RABATU**

# WYWAŻARKI DO SAMOCHODÓW OSOBOWYCH/VAN/BUS

## EM 9380 C XLINE TOUCHSCREEN

## EM 9380 C XLINE



### STANDARDOWE AKCESORIA

Kod  
8-21100221

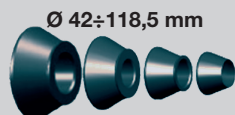

Kod  
802227308

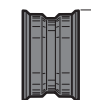

28"



Kod	Zasilanie	Opis	Cena netto
0-21193806/16	200-230V / 1P <sub>H</sub> / 50-60Hz	<b>EM9380C XLine TOUCHSCREEN</b> Wyważarka z dotykowym ekranem, z elektromechanicznym uchwytem szybkoocującym za pomocą pedału, wskaźnikiem laserowym, automatycznym wprowadzaniem danych oraz systemem oszczędzania ciężarków (program WM). <b>Zalecamy dokupić opcjonalnie AWD (+ 2 635,00 zł) i KLIP (+ 222,00).</b>	31 714,00
0-21193802/16	200-230V / 1P <sub>H</sub> / 50-60Hz	<b>EM9380C XLine</b> Wyważarka z monitorem LCD, z elektromechanicznym uchwytem szybkoocującym za pomocą pedału, wskaźnikiem laserowym, automatycznym wprowadzaniem danych oraz systemem oszczędzania ciężarków (program WM). <b>Zalecamy dokupić opcjonalnie AWD (+ 2 635,00 zł) i KLIP (+ 222,00).</b>	28 244,00

**ODLICZ OD CENY -15 % RABATU**



www.corghi.pl

# WYWAŻARKI DO SAMOCHODÓW OSOBOWYCH/VAN/BUS

## EM 9380 XLINE TOUCHSCREEN

## EM 9380 XLINE



Kod  
8-21100221

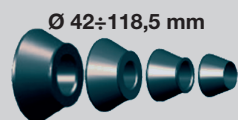
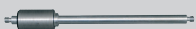

Kod  
802227308



### STANDARDOWE AKCESORIA



Kod	Zasilanie	Opis	Cena netto
0-21193805/16	200-230V / 1P <sub>H</sub> / 50-60Hz	<b>EM9380 XLine TOUCHSCREEN</b> Wyważarka z monitorem LCD, automatycznym wprowadzaniem danych, wskaźnikiem laserowym oraz systemem oszczędzania ciężarków (program WM). <b>Zalecamy dokupić opcjonalnie AWD (+ 2 635,00 zł) i KLIP (+ 222,00).</b>	26 596,00
0-21193800/16	200-230V / 1P <sub>H</sub> / 50-60Hz	<b>EM9380 XLine</b> Wyważarka z monitorem LCD, automatycznym wprowadzaniem danych, wskaźnikiem laserowym oraz systemem oszczędzania ciężarków (program WM). <b>Zalecamy dokupić opcjonalnie AWD (+ 2 635,00 zł) i KLIP (+ 222,00).</b>	23 126,00

**ODLICZ OD CENY -15 % RABATU**



www.corghi.pl



# WYWAŻARKI DO SAMOCHODÓW OSOBOWYCH/VAN/BUS

## EM 9350 C XLINE



### STANDARDOWE AKCESORIA

Kod  
8-21100221



Kod  
802227308

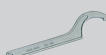

Kod	Zasilanie	Opis	Cena netto
0-21193502/16	200-230V / 1Ph / 50-60Hz	<b>EM9350C XLine</b> Wyważarka z wyświetlaczem, wskaźnikiem laserowym, z elektromechanicznym uchwytem szybkołączącym za pomocą pedału, automatycznym wprowadzaniem danych. <b>Zalecamy dokupić opcjonalnie AWD (+ 2 635,00 zł) i KLIP (+ 222,00).</b>	<b>23 086,00</b>

**ODLICZ OD CENY -15 % RABATU**

# WYWAŻARKI DO SAMOCHODÓW OSOBOWYCH/VAN/BUS

## EM 9350 XLINE



### STANDARDOWE AKCESORIA

Kod  
8-21100221



Ø 42÷118,5 mm

Kod  
802227308



x3



28''



Kod	Zasilanie	Opis	Cena netto
0-21193500/16	200-230V / 1Pn / 50-60Hz	<b>EM9350 XLine</b> Wyważarka z wyświetlaczem, wskaźnikiem laserowym, automatycznym wprowadzaniem danych. <b>Zalecamy dokupić opcjonalnie AWD (+ 2 635,00 zł) i KLIP (+ 222,00).</b>	<b>17 878,00</b>

**ODLICZ OD CENY -15 % RABATU**

## EM 9280 C COMPACTLINE



### STANDARDOWE AKCESORIA



Kod	Zasilanie	Opis	Cena netto
0-21192804/16	200-230V / 1P <sub>H</sub> / 50-60Hz	<b>EM9280C CompactLine</b> Wyważarka z monitorem LCD, pneumatycznym uchwytem szybkoocującym, automatycznym wprowadzeniem danych, z automatycznym zatrzymaniem na koniec wyrzutu, z systemem RPA, z systemem oszczędzania ciężarków (Program WM). <b>Zalecamy dokupić opcjonalnie AWD (+ 2 635,00 zł), LASER (+ 1 413,00), KLIP (+ 222,00) oraz PL50 (+ 359,00).</b>	<b>24 998,00</b>

Polecane

**ODLICZ OD CENY -15 % RABATU**

# WYWAŻARKI DO SAMOCHODÓW OSOBOWYCH/VAN/BUS

## EM 9280 COMPACTLINE



Kod  
8-21100221

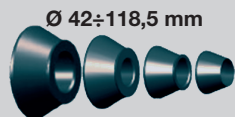

Kod  
802227308



### STANDARDOWE AKCESORIA



28"



Kod	Zasilanie	Opis	Cena netto
0-21192800/16	200-230V / 1Ph / 50-60Hz	<b>EM9280 CompactLine</b> Wyważarka z monitorem LCD, automatycznym wprowadzeniem danych, z automatycznym zatrzymaniem na koniec wyrzutu, z systemem RPA, z systemem oszczędzania ciężarków (Program WM). <b>Zalecamy dokupić opcjonalnie AWD (+ 2 635,00 zł), LASER (+ 1 413,00), KLIP (+ 222,00) oraz PL50 (+ 359,00).</b>	<b>20 082,00</b>

**ODLICZ OD CENY -15 % RABATU**

# WYWAŻARKI DO SAMOCHODÓW OSOBOWYCH/VAN/BUS

## EM 9250 COMPACTLINE



### STANDARDOWE AKCESORIA

Kod  
8-21100221

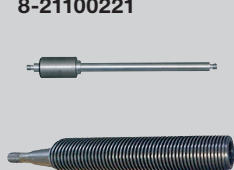

Ø 42÷118,5 mm

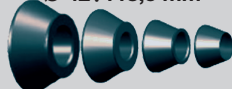

x3  
Kod  
802227308



28"

Wersja premium



Kod	Zasilanie	Opis	Cena netto
0-21192508/16	200-230V / 1P <sub>H</sub> / 50-60Hz	<b>EM 9250 CompactLine Wersja PREMIUM:</b> Wyświetlacz, automatyczne wprowadzenie danych oraz automatyczne zatrzymanie na koniec wyrzutu. Elektryczny hamulec oraz system RPA. <b>Zalecamy dokupić opcjonalnie AWD (+ 2 635,00 zł), LASER (+ 1 413,00), KLIP (+ 222,00) oraz PL50 (+ 359,00).</b>	14 181,00
0-21192504/16	200-230V / 1P <sub>H</sub> / 50-60Hz	<b>EM 9250 CompactLine Wersja PROFESSIONAL:</b> maszyna z wyświetlaczem LCD z automatycznym wprowadzaniem danych i automatycznym hamulcem na końcu wirowania. <b>Zalecamy dokupić opcjonalnie LASER (+ 1 413,00), KLIP (+ 222,00) oraz PL50 (+ 359,00).</b>	13 305,00
0-21192500/16	200-230V / 1P <sub>H</sub> / 50-60Hz	<b>EM 9250 CompactLine Wersja BASIC:</b> maszyna z wyświetlaczem LCD z ręcznym wprowadzaniem danych i automatycznym hamulcem na końcu wirowania. <b>Zalecamy dokupić opcjonalnie LASER (+ 1 413,00), KLIP (+ 222,00) oraz PL50 (+ 359,00).</b>	11 546,00

**ODLICZ OD CENY -15 % RABATU**

# WYWAŻARKI DO MOTOCYKLI

## EM 9250 BASIC BIKELINE



STANDARDOWE AKCESORIA



Kod  
8-21100221

Kod  
802227308

Kod	Zasilanie	Opis	Cena netto
0-21192512/16	200-230V / 1Ph / 50-60Hz	<b>EM 9250</b> Wyważarka do kół motocyklowych z ręcznym wprowadzeniem danych i ręcznym mocowaniem kół, zawiera wyświetlacz LCD. W zestawie z BIKE UNIVERSAL KIT i PRA4.	<b>14 820,00</b>



**ODLICZ OD CENY -15 % RABATU**

## AKCESORIA DO WYWAŻAREK SAMOCHODOWYCH I MOTOCYKLOWYCH

	Opis	Kod	Cena netto	EYE-LIGHT PLUS	EM9980 C PLUS	EM9780 C PLUS	EM9580 C Plus TOUCHSCR	EM9580 Plus TOUCHSCREEN	EM9580 C Plus	EM9580 Plus	EM9550 C Plus	EM9550 Plus	EM9380 C / TOUCHSCREEN	EM9380 / TOUCHSCREEN	EM9350 C	EM9350	EM9280 C	EM9280	EM9250 C PREMIUM	EM9250 PREMIUM	EM9250 PROFESSIONAL	EM9250 BASIC	EM9250 BASIC BIKELINE	
<b>MONITORY</b>																								
	Monitor 22"	8-21100234	1 407,00	-	-	-	-	-	O	O	-	-	O	O	-	-	-	-	-	-	-	-	-	-
	Zestaw do czyszczenia monitorów	8-21120006	114,00	O	O	O	O	O	O	O	-	-	O	O	-	-	O	O	-	-	-	-	-	-

■ = Standard    O = Kompatybilne    - = NIEkompatybilne

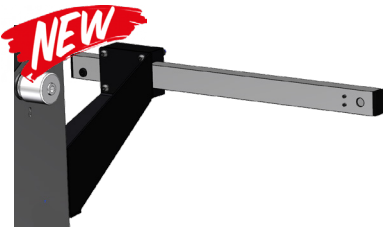



## AKCESORIA DO WYWAŻAREK SAMOCHODOWYCH I MOTOCYKLOWYCH

	Opis	Kod	Cena netto	EYE-LIGHT PLUS	EM9980 C PLUS	EM9780 C PLUS	EM9580 C Plus TOUCHScr	EM9580 Plus TOUCHSCREEN	EM9580 C Plus	EM9580 Plus	EM9550 C Plus	EM9550 Plus	EM9380 C / TOUCHSCREEN	EM9380 / TOUCHSCREEN	EM9350 C	EM9350	EM9280 C	EM9280	EM9250 C PREMIUM	EM9250 PREMIUM	EM9250 PROFESSIONAL	EM9250 BASIC	EM9250 Basic BikeLine	
<b>URZĄDZENIA ELEKTRONICZNE</b>																								
 LAN CONNECTION KIT	<b>ZESTAW DO PODŁĄCZENIA SIECI LAN</b> Zestaw do podłączenia wyważarki do sieci systemu zarządzania firmą; pozwala przeglądać, archiwizować i drukować zdalnie różne raporty pomiarowe i diagnostyczne wyważarki diagnostycznej.	8-21100255	1 154,00	O	O	O	O	C	O	O	-	-	O	O	-	-	O	O	-	-	-	-	-	-
	<b>Zestaw RRS-2, zestaw sonaru</b>	8-21100277	1 986,00	-	-	-	-	-	-	-	-	-	-	O	O	-	-	O	O	-	-	-	-	-
	<b>EG1</b> Pomiar szerokości koła.	8-21100074	2 433,00	-	-	-	-	-	-	-	-	-	-	-	-	-	-	-	-	-	-	O	-	-
	<b>WYKRYWANIE ROZMIARÓW KOŁA</b> cyfrowy miernik do pozyskiwania średnicy i odległości. Maksymalna precyzja przy wykorzystaniu systemu FSP, który automatycznie dobiera odpowiedni program wyważania.	8-21120022	975,00	-	-	-	-	-	-	-	-	-	O	O	O	O	O	O	O	O	O	O	O	O

■ = Standard    O = Kompatybilne    - = NIEkompatybilne



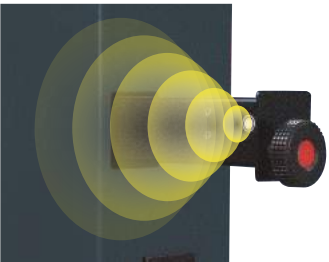

## AKCESORIA DO WYWAŻAREK SAMOCHODOWYCH I MOTOCYKLOWYCH

Opis	Kod	Cena netto	EYE-LIGHT PLUS	EM9980 C PLUS	EM9780 C PLUS	EM9580 C Plus TOUCHSCR	EM9580 Plus TOUCHSCREEN	EM9580 C Plus	EM9580 Plus	EM9550 C Plus	EM9550 Plus	EM9380 C / TOUCHSCREEN	EM9380 / TOUCHSCREEN	EM9350 C	EM9350	EM9280 C	EM9280	EM9250 C PREMIUM	EM9250 PREMIUM	EM9250 PROFESSIONAL	EM9250 BASIC	EM9250 BASIC BIKE LINE	
				<b>WYKRYWANIE ROZMIARÓW KOŁA</b> cyfrowy miernik do pozyskiwania średnicy i odległości. Maksymalna precyzja przy wykorzystaniu systemu FSP, który automatycznie dobiera odpowiedni program wyważania.	<b>8-21120023</b>	<b>975,00</b>	-	-	-	■	■	■	■	■	■	-	-	-	-	-	-	-	-
	<b>Laser &amp; Led</b> Zestaw wskaźnika laserowego i światło LED	<b>8-21100238</b>	<b>1 413,00</b>	-	-	-	-	-	-	-	-	-	-	-	-	○	○	○	○	○	○	○	-
	<b>AWD</b> Zestaw do ultradźwiękowego pomiaru szerokości koła Sonar Sensor.	<b>8-21100232</b>	<b>2 635,00</b>	-	-	■	○	○	○	○	○	○	○	○	○	○	○	○	○	○	-	-	-
	<b>ZESTAW DO MONTAŻU - WINUT</b> do dodania systemu WiNut do wyważarek wyprodukowanych bez niego; EM92xx-C i EM93xx-C produkowane od lipca 2019 r	<b>8-21100242</b>	<b>2 993,00</b>	○	○	○	○	-	○	-	-	-	○	-	○	-	○	-	-	-	-	-	-
	<b>Zestaw Sonar RUNOUT z nowymi funkcjami BESTFIT</b>	<b>8-21100250</b>	<b>2 574,00</b>	-	-	○	○	○	○	-	-	-	-	-	-	-	-	-	-	-	-	-	-





■ = Standard    ○ = Kompatybilne    - = NIEkompatybilne

## AKCESORIA DO WYWAŻAREK SAMOCHODOWYCH I MOTOCYKLOWYCH

	Opis	Kod	Cena netto	EYE-LIGHT PLUS	EM9980 C PLUS	EM9780 C PLUS	EM9580 C Plus TouchScr	EM9580 Plus TouchSCREEN	EM9580 C Plus	EM9580 Plus	EM9550 C Plus	EM9550 Plus	EM9380 C / TOUCHSCREEN	EM9380 / TOUCHSCREEN	EM9350 C	EM9350	EM9280 C	EM9280	EM9250 C PREMIUM	EM9250 PREMIUM	EM9250 PROFESSIONAL	EM9250 BASIC	EM9250 BASIC BIKELINE
<b>PODNOŚNIKI</b>																							
	<b>TT-0</b> Automatyczny samopoziomujący podnośnik koła. Zasilanie pneumatyczne. Udźwig 80kg.	8-21100230	9 617,00	0	0	0	0	0	0	0	0	0	0	0	0	0	0	0	0	0	0	0	0
	<b>TT-R</b> Profesjonalny regulowany podnośnik nożycowy, sterowanie jedną ręką, udźwig 80 kg	8-21100248	6 677,00	0	0	0	0	0	0	0	0	0	0	0	0	0	0	0	0	0	0	0	0
	<b>Zestaw montażowy do podnośnika TT-ZERO GRAVITY i TT-R</b> , tylko do EM9380, EM9350, EM9280 i 9250.	8-21100231	194,00	-	-	-	-	-	-	-	-	-	0	0	0	0	0	0	0	0	0	0	0

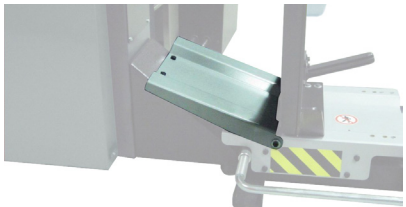

■ = Standard    O = Kompatybilne    - = NIEkompatybilne

## AKCESORIA DO WYWAŻAREK SAMOCHODOWYCH I MOTOCYKLOWYCH

	Opis	Kod	Cena netto	EYE-LIGHT PLUS	EM9980 C PLUS	EM9780 C PLUS	EM9580 C Plus TouchScr	EM9580 Plus TOUCHSCREEN	EM9580 C Plus	EM9580 Plus	EM9550 C Plus	EM9550 Plus	EM9380 C / TOUCHSCREEN	EM9380 / TOUCHSCREEN	EM9350 C	EM9350	EM9280 C	EM9280	EM9250 C PREMIUM	EM9250 PREMIUM	EM9250 PROFESSIONAL	EM9250 BASIC	EM9250 BASIC BIKELINE
	<b>Zestaw klap do podnośnika</b> TT-ZERO GRAVITY i TT-R (umożliwia montaż podnośnika na wyważarce ze stopką boczną) do EM9280, EM9250.	<b>8-21600132</b>	<b>556,00</b>	-	-	-	-	-	-	-	-	-	-	-	-	-	0	0	0	0	0	0	0
	<b>TT 80</b> Uniwersalny podnośnik pneumatyczny, maks. obciążenie kg 80.	<b>8-21100161</b>	<b>4 691,00</b>	0	0	0	0	0	0	0	0	0	0	0	0	0	0	0	0	0	0	0	0
	<b>FTT1</b> Zestaw montażowy do TT80.	<b>8-21100163</b>	<b>194,00</b>	-	-	-	-	-	-	-	-	-	0	0	0	0	0	0	0	0	0	0	0
	<b>FTT2</b> Zestaw montażowy do TT80.	<b>8-21120002</b>	<b>194,00</b>	0	0	0	0	0	0	0	0	0	-	-	-	-	-	-	-	-	-	-	-

■ = Standard    0 = Kompatybilne    - = NIEkompatybilne

## AKCESORIA DO WYWAŻAREK SAMOCHODOWYCH I MOTOCYKLOWYCH

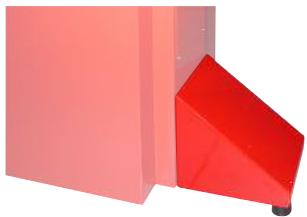
	Opis	Kod	Cena netto	EYE-LIGHT PLUS	EM9980 C PLUS	EM9780 C PLUS	EM9580 C Plus TouchScr	EM9580 Plus TouchSCREEN	EM9580 C Plus	EM9580 Plus	EM9550 C Plus	EM9550 Plus	EM9380 C / TOUCHSCREEN	EM9380 / TOUCHSCREEN	EM9350 C	EM9350	EM9280 C	EM9280	EM9250 C PREMIUM	EM9250 PREMIUM	EM9250 PROFESSIONAL	EM9250 BASIC	EM9250 BASIC BIKELINE	
<b>ZESTAWY MODERNIZACYJNE</b>																								
	<b>Boczny panel podtrzymujący</b> : panel podtrzymujący uchwyt na akcesoria do zestawów centrujących i zestawów HPC, malowany na kolor czerwony (dla wyważarek pomalowanych już na kolor czerwony RAL 3002 - /16)	8-21100258/16	467,00	-	-	-	-	-	-	-	-	-	-	-	-	-	0	0	0	0	0	0	0	0
	<b>Boczny panel podtrzymujący</b> : panel podtrzymujący uchwyt na akcesoria do zestawów centrujących i zestawów HPC, malowany na kolor czerwony (dla wyważarek niepomalowanych na kolor czerwony RAL 3002 - /16)	8-21100258/90	467,00	-	-	-	-	-	-	-	-	-	-	-	-	-	0	0	0	0	0	0	0	0
	<b>Panel nośny do zestawu centrującego</b> HPC High Precision Collets, lakierowany na kolor czerwony (do wyważarek lakierowanych już na kolor czerwony RAL 3002 w /16)	8-21100253/16	933,00	-	0	0	0	0	0	0	0	0	-	-	-	-	-	-	-	-	-	-	-	-
	<b>Panel nośny do zestawu centrującego</b> HPC High Precision Collets, lakierowany na kolor czerwony (do wyważarek niepomalowanych na kolor czerwony RAL 3002 w /16)	8-21100253/90	933,00	■	0	0	0	0	0	0	0	0	-	-	-	-	-	-	-	-	-	-	-	-
	<b>PL50</b> Stopka do montażu bez kotwienia do podłoża. Maksymalny ciężar koła jest ograniczony do 50 kg z zamontowaną stopą (CZERWONA)	8-21100158/16	359,00	-	-	-	-	-	-	-	-	-	-	-	-	-	0	0	0	0	0	0	0	0
	<b>PL50</b> Stopka do montażu bez kotwienia do podłoża. Maksymalny ciężar koła jest ograniczony do 50 kg z zamontowaną stopą (CZARNA)	8-21100158/90	359,00	-	-	-	-	-	-	-	-	-	-	-	-	-	0	0	0	0	0	0	0	0

■ = Standard    0 = Kompatybilne    - = NIEkompatybilne

## AKCESORIA DO WYWAŻAREK SAMOCHODOWYCH I MOTOCYKLOWYCH





	Opis	Kod	Cena netto	EYE-LIGHT PLUS	EM9980 C PLUS	EM9780 C PLUS	EM9580 C Plus TOUCHScr	EM9580 Plus TOUCHSCREEN	EM9580 C Plus	EM9580 Plus	EM9550 C Plus	EM9550 Plus	EM9380 C / TOUCHSCREEN	EM9380 / TOUCHSCREEN	EM9350 C	EM9350	EM9280 C	EM9280	EM9250 C PREMIUM	EM9250 PREMIUM	EM9250 PROFESSIONAL	EM9250 BASIC	EM9250 Basic BikeLINE	
	Zestaw kolorów do personalizacji tylko dla EM9250 i EM9280	8-21100245/xx	368,00	-	-	-	-	-	-	-	-	-	-	-	-	-	O	O	O	O	O	O	O	O

■ = Standard    O = Kompatybilne    - = NIEkompatybilne







www.corgi.pl

# AKCESORIA DO WYWAŻAREK SAMOCHODOWYCH I MOTOCYKLOWYCH

	Opis	Kod	Cena netto	EYE-LIGHT PLUS	EM9980 C PLUS	EM9780 C PLUS	EM9580 C Plus TouchScr	EM9580 Plus TOUCHSCREEN	EM9580 C Plus	EM9580 Plus	EM9550 C Plus	EM9550 Plus	EM9380 C / TOUCHSCREEN	EM9380 / TOUCHSCREEN	EM9350 C	EM9350	EM9280 C	EM9280	EM9250 C PREMIUM	EM9250 PREMIUM	EM9250 PROFESSIONAL	EM9250 BASIC	EM9250 BASIC BIKELINE	
<b>RÓŻNE</b>																								
	<b>ZESTAW DOZOWNIKA</b> : łatwy w użyciu zestaw dozujący do odważników.	<b>8-21100251</b>	<b>401,00</b>	O	O	O	O	O	O	O	O	O	O	O	O	O	O	O	O	O	O	O	O	O
	<b>Samoprzylepna rolka odważników:</b> metalowa szpula 5 gr x 1200 - 6 kg	<b>8-21100252</b>	<b>208,00</b>	O	O	O	O	O	O	O	O	O	O	O	O	O	O	O	O	O	O	O	O	O
	Kompletny <b>zestaw osłon kół</b> do serii EM92xx	<b>8-21100246/90</b>	<b>1 413,00</b>	-	-	-	-	-	-	-	-	-	-	-	-	-	O	O	O	O	O	O	O	O
	<b>Hamulec zaciskowy pedału CB</b> tylko dla EM9250.	<b>8-21100191</b>	<b>655,00</b>	-	-	-	-	-	-	-	-	-	-	-	-	-	-	-	-	-	O	O	O	O
	<b>AWR</b> urządzenie do usuwania ciężarków.	<b>802461006</b>	<b>95,00</b>	O	O	O	O	O	O	O	O	O	O	O	O	O	O	O	O	O	O	O	O	O

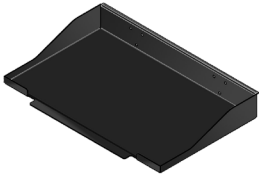

■ = Standard    O = Kompatybilne    - = NIEkompatybilne

## AKCESORIA DO WYWAŻAREK SAMOCHODOWYCH I MOTOCYKLOWYCH

	Opis	Kod	Cena netto	EYE-LIGHT PLUS	EM9980 C PLUS	EM9780 C PLUS	EM9580 C Plus TOUCHSCR	EM9580 Plus TOUCHSCREEN	EM9580 C Plus	EM9580 Plus	EM9550 C Plus	EM9550 Plus	EM9380 C / TOUCHSCREEN	EM9380 / TOUCHSCREEN	EM9350 C	EM9350	EM9280 C	EM9280	EM9250 C PREMIUM	EM9250 PREMIUM	EM9250 PROFESSIONAL	EM9250 BASIC	EM9250 BASIC BIKELINE	
	<b>PR Inkjet</b> drukarka USB.	<b>8-21120005</b>	<b>711,00</b>	O	O	O	O	O	-	-	-	-	-	-	-	-	-	-	-	-	-	-	-	-
	<b>PRS</b> podstawka na drukarkę.	<b>8-21100236/90</b>	<b>443,00</b>	O	O	O	O	O	-	-	-	-	-	-	-	-	-	-	-	-	-	-	-	-
	<b>PFC</b> szczypce do ciężarków.	<b>802227308</b>	<b>240,00</b>	■	■	■	■	■	■	■	■	■	■	■	■	■	■	■	■	■	■	■	■	■
	<b>Klip</b> do wspomagania nakładania ciężarków samoprzylepnych dla EM92XX, EM93XX.	<b>8-21100159</b>	<b>222,00</b>	-	-	-	■	■	■	■	■	■	O	O	O	O	O	O	O	O	O	O	O	O
	<b>PPT</b> zacisk docisku stopy.	<b>8-21100225</b>	<b>1 535,00</b>	O	O	O	O	O	O	O	O	O	O	O	O	O	O	O	O	O	O	O	O	O

■ = Standard    O = Kompatybilne    - = NIEkompatybilne

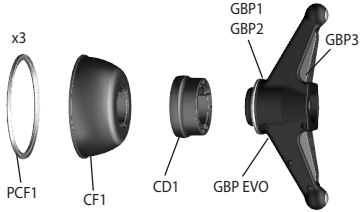

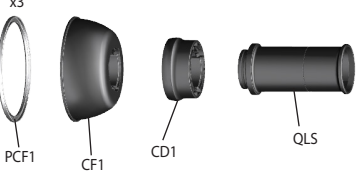
# AKCESORIA DO WYWAŻAREK SAMOCHODOWYCH I MOTOCYKLOWYCH

	Opis	Kod	Cena Netto	EYE-LIGHT PLUS	EM9980 C PLUS	EM9780 C PLUS	EM9580 C Plus TouchScr	EM9580 Plus TOUCHSCREEN	EM9580 C Plus	EM9580 Plus	EM9550 C Plus	EM9550 Plus	EM9380 C / TOUCHSCREEN	EM9380 / TOUCHSCREEN	EM9350 C	EM9350	EM9280 C	EM9280	EM9250 C PREMIUM	EM9250 PREMIUM	EM9250 PROFESSIONAL	EM9250 BASIC	EM9250 BASIC BIKELINE	
<b>ZESTAWY DO CENTROWANIA KÓŁ</b>																								
	<b>GBP40 EVO KIT</b> – profesjonalny zestaw szybkich nakrętek $\varnothing 40 \times 3 \text{mm}$	<b>8-21100289</b>	<b>632,00</b>	-	-	-	-	■	-	■	-	■	-	■	-	■	-	■	-	■	■	■	■	○
	<b>PCF1</b> Ochroniac koła do centrowania felg aluminiowych	<b>4-115868</b>																						
	<b>CF1</b> Nasadka zacisku koła	<b>4-115863</b>																						
	<b>CD1</b> Nasadka dystansowa	<b>4-115864</b>																						
	<b>GBP EVO</b> Szybka nakrętkat	<b>5-101561</b>																						
	<b>GBP1</b> Zacisk „R”	<b>4-104798</b>																						
	<b>GBP2</b> Zacisk „L”	<b>4-104799</b>																						
	<b>GBP3</b> Lever	<b>4-104796</b>																						
	<b>CCK3 EVO KIT</b> – zestaw stożków centrujących $\varnothing 40 \text{mm}$ $42 \div 103,5 \text{mm}$	<b>8-21100280</b>	<b>759,00</b>	■	■	■	■	■	■	■	■	■	■	■	■	■	■	■	■	■	■	■	■	○
	<b>CP1</b> Mały stożek $\varnothing 42 \div 68 \text{ mm}$	<b>5-107970</b>																						
	<b>CP2</b> Średni stożek $\varnothing 60 \div 87 \text{ mm}$	<b>5-107968</b>																						
	<b>CP3</b> Duży stożek $\varnothing 83 \div 103 \text{ mm}$	<b>5-107969</b>																						
	<b>MFL</b> – wał gwintowany XL $\varnothing 40 \times 3 \text{mm}$ - długość: 220mm	<b>8-21100193</b>	<b>834,00</b>	-	-	-	-	○	-	○	-	○	-	○	-	○	-	○	-	○	○	○	○	○
	<b>MBP40 EVO KIT</b> – Zestaw tulei blokujących do elektrycznego lub pneumatycznego systemu blokowania kół	<b>8-21100285</b>	<b>956,00</b>	■	■	■	■	-	■	-	■	-	■	-	■	-	■	-	■	-	-	-	-	
	<b>PCF1</b> Ochroniac koła do centrowania felg aluminiowych	<b>4-115868</b>																						
	<b>CF1</b> Nasadka zacisku koła	<b>4-115863</b>																						
	<b>CD1</b> Nasadka dystansowa	<b>4-115864</b>																						
	<b>QLS</b> Szybkozamykający rękaw	<b>5-107394</b>																						

■ = Standard    ○ = Kompatybilne    - = NIEkompatybilne



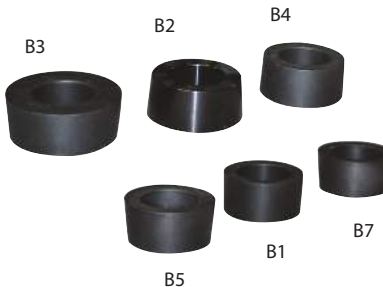



# AKCESORIA DO WYWAŻAREK SAMOCHODOWYCH I MOTOCYKLOWYCH

	Opis	Kod	Cena Netto	EYE-LIGHT PLUS	EM9980 C PLUS	EM9780 C PLUS	EM9680 C Plus TOUCHSCR	EM9580 Plus TOUCHSCREEN	EM9580 C Plus	EM9580 Plus	EM9550 C Plus	EM9550 Plus	EM9380 C / TOUCHSCREEN	EM9380 / TOUCHSCREEN	EM9350 C	EM9350	EM9280 C	EM9280	EM9250 C PREMIUM	EM9250 PREMIUM	EM9250 PROFESSIONAL	EM9250 BASIC	EM9250 Basic BikeLine	
<b>ZESTAWY DO CENTROWANIA KÓŁ</b>																								
	<b>SBC</b> Zestaw 6 tulei do centrowania odwrótej strony Ø 40 mm	<b>8-21100082</b>	<b>1 243,00</b>	○	○	○	○	○	○	○	○	○	○	○	○	○	○	○	○	○	○	○	○	
	<b>B1</b> AUDI, BMW, Chrysler, Opel, Rover, Seat, VW, Daewoo, Galaxy (Ford), Lotus, British-Leyland, Smart (Mercedes), Skoda	<b>4-105075</b>																						
	<b>B2</b> Citroën, Hyundai, Lancia, Maserati, Mazda, Mercedes, Mitsubishi, Nissan, Opel, Peugeot, Saab, Volvo.	<b>4-105076</b>																						
	<b>B3</b> BMW, Jaguar, Aston Martin.	<b>4-105077</b>																						
	<b>B4</b> Ford, Honda, Rover	<b>4-105078</b>																						
	<b>B5</b> Autobianchi, Alfa Romeo, Citroën, Fiat, Lada, Lancia, Jalbot, Biturbo (Maserati), Mazda, Nissan, Peugeot, Porsche, Renault, 2600-3500 serie (Rover), Seat =>90, Skoda, Toyota.	<b>4-105079</b>																						
	<b>B7</b> Citroën, Daihatsu, Honda, Kia, Mazda, Mitsubishi, Peugeot, Rover, Subaru, Toyota, Agila (Opel), Suzuki, Hyuday.	<b>4-105080</b>																						
	Zestaw centrujący <b>HPC</b> High Precision Collets (8 dwustronnych, lekko stożkowych tulei)	<b>8-21100244</b>	<b>2 809,00</b>	■	○	○	○	○	○	○	○	○	○	○	○	○	○	○	○	○	○	○	○	
	Wózek do zestawu HPC.	<b>8-21100243/90</b>	<b>1 130,00</b>	○	○	○	○	○	○	○	○	○	○	○	○	○	○	○	○	○	○	○	○	

■ = Standard    ○ = Kompatybilne    - = NIEkompatybilne

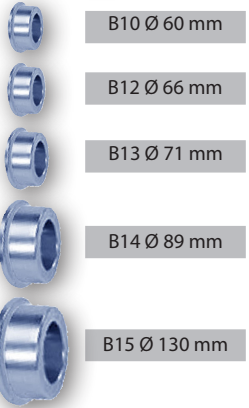



# AKCESORIA DO WYWAŻAREK SAMOCHODOWYCH I MOTOCYKLOWYCH

Opis	Kod	Cena Netto	EYE-LIGHT PLUS	EM9980 C PLUS	EM9780 C PLUS	EM9580 C Plus TOUCHSCR	EM9580 Plus TOUCHSCREEN	EM9580 C Plus	EM9580 Plus	EM9550 C Plus	EM9550 Plus	EM9380 C / TOUCHSCREEN	EM9380 / TOUCHSCREEN	EM9350 C	EM9350	EM9280 C	EM9280	EM9250 C PREMIUM	EM9250 PREMIUM	EM9250 PROFESSIONAL	EM9250 BASIC	EM9250 BASIC BIKELINE	
<b>ZESTAWY DO CENTROWANIA KÓŁ</b>																							
	<b>Tuleja B6 „Racing”</b> Ø 67 mm do FERRARI / MASERATI	<b>8-21100083</b>	<b>420,00</b>	O	O	O	O	O	O	O	O	O	O	O	O	O	O	O	O	O	O	O	O
	<b>Tuleja B9 OPEL</b> Ø 56,5-65-70,1 mm	<b>8-21100085</b>	<b>420,00</b>	O	O	O	O	O	O	O	O	O	O	O	O	O	O	O	O	O	O	O	O
	<b>RENAULT</b> Zestaw 5 tulei Renault	<b>8-21100229</b>	<b>1 535,00</b>	O	O	O	O	O	O	O	O	O	O	O	O	O	O	O	O	O	O	O	O
	<b>B10</b> Ø 60 mm	4-105106																					
	<b>B12</b> Ø 66 mm	4-107025																					
	<b>B13</b> Ø 71 mm	4-107026																					
	<b>B14</b> Ø 89 mm	4-107027																					
	<b>B15</b> Ø 130 mm	4-107028																					
	<b>Zestaw BMW/MINI</b> Ø 66,5 / Ø 56,5 - Ø 72,5 - Ø 74 mm B6 - Ø 66.5 mm - 4-105103 B11 - Ø 56.5 - Ø 72.5 - Ø 74 mm - 4-105108	<b>8-21100228</b>	<b>777,00</b>	O	O	O	O	O	O	O	O	O	O	O	O	O	O	O	O	O	O	O	O
	<b>Zestaw MERCEDES</b> Ø 57. Ø 65, Ø 66,5, Ø 84 mm	<b>8-21400022</b>	<b>792,00</b>	O	O	O	O	O	O	O	O	O	O	O	O	O	O	O	O	O	O	O	O
	B16 Ø 57, Ø 66,5, Ø 67 mm	4-138168																					
	B17 Ø 60, Ø 84 mm	4-138169																					

■ = Standard    O = Kompatybilne    - = NIEkompatybilne



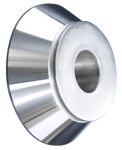



# AKCESORIA DO WYWAŻAREK SAMOCHODOWYCH I MOTOCYKLOWYCH

Opis	Kod	Cena netto	EYE-LIGHT PLUS	EM9980 C PLUS	EM9780 C PLUS	EM9580 C Plus TouchScr	EM9580 Plus TOUCHSCREEN	EM9580 C Plus	EM9580 Plus	EM9550 C Plus	EM9550 Plus	EM9380 C / TOUCHSCREEN	EM9380 / TOUCHSCREEN	EM9350 C	EM9350	EM9280 C	EM9280	EM9250 C PREMIUM	EM9250 PREMIUM	EM9250 PROFESSIONAL	EM9250 Basic	EM9250 Basic BIKELINE									
<b>CENTROWANIE KOŁA</b>																															
 CIP	<b>CIP Stożek pośredni Ø 55÷72 mm</b> Niezastąpione akcesorium do kół z plastikowymi kołpakami i kół z krótkimi otworami w piasku. Wymiary CIP zapobiegają jego wystawianiu przez otwór piasty z przodu, zapobiegając uszkodzeniu przodu koła, ponieważ w tych kołach przednia średnica otworu piasty jest mniejsza niż średnica tylnego otworu centrującego.	8-21100200	312,00	O	O	O	O	O	O	O	O	O	O	O	O	O	O	O	O	O	O	O	O								
 CGF    PCF1    CF1	<b>ARF Akcesorium do kół terenowych Ø102,5÷118,5mm Ø 101÷119 mm.</b> <table border="1"> <tr> <td>CGF</td> <td>Stożek do kół terenowych (dostawcze)</td> <td>5-107971</td> </tr> <tr> <td>PCF1</td> <td>Ochroniacz koła do centrowania felg aluminiowych</td> <td>4-115868</td> </tr> <tr> <td>CF1</td> <td>Kołpak mocujący koła ø 147 mm</td> <td>4-115863</td> </tr> </table>	CGF	Stożek do kół terenowych (dostawcze)	5-107971	PCF1	Ochroniacz koła do centrowania felg aluminiowych	4-115868	CF1	Kołpak mocujący koła ø 147 mm	4-115863	8-21100080	500,00	■	■	■	■	■	■	■	■	■	■	■	■	■	■	■	■	■	■	O
CGF	Stożek do kół terenowych (dostawcze)	5-107971																													
PCF1	Ochroniacz koła do centrowania felg aluminiowych	4-115868																													
CF1	Kołpak mocujący koła ø 147 mm	4-115863																													
	Stożek centrujący Ø95 do Ø137 mm.	8-21100096	773,00	O	O	O	O	O	O	O	O	O	O	O	O	O	O	O	O	O	O	O	O								
 DX2    CST	<b>Stożek do lekkich ciężarówek Ø 110÷132 mm.</b> <table border="1"> <tr> <td>DX2</td> <td>podkładka dystansowa</td> <td>341843</td> </tr> <tr> <td>CST</td> <td>Stożek do lekkiej ciężarówki ø 110÷132 mm</td> <td>4-112320</td> </tr> </table>	DX2	podkładka dystansowa	341843	CST	Stożek do lekkiej ciężarówki ø 110÷132 mm	4-112320	8-21100201	726,00	O	O	O	O	O	O	O	O	O	O	O	O	O	O	O	O	O	O	O			
DX2	podkładka dystansowa	341843																													
CST	Stożek do lekkiej ciężarówki ø 110÷132 mm	4-112320																													

■ = Standard    O = Kompatybilne    - = NIEkompatybilne







# AKCESORIA DO WYWAŻAREK SAMOCHODOWYCH I MOTOCYKLOWYCH

Opis	Kod	Cena netto	EYE-LIGHT PLUS	EM9980 C PLUS	EM9780 C PLUS	EM9580 C Plus TOUCHSCR	EM9580 Plus TOUCHSCREEN	EM9580 C Plus	EM9580 Plus	EM9550 C Plus	EM9550 Plus	EM9380 C / TOUCHSCREEN	EM9380 / TOUCHSCREEN	EM9350 C	EM9350	EM9280 C	EM9280	EM9250 C PREMIUM	EM9250 PREMIUM	EM9250 PROFESSIONAL	EM9250 BASIC	EM9250 Basic BikeLINE	
<b>CENTROWANIE KOŁA</b>																							
 <p>DX1      CF1      CF2</p>	<b>DX/CBF</b> Akcesorium centrujące do kół samochodów dostawczych i terenowych z centralnym otworem o średnicy 117÷173 mm.	<b>8-21100141</b>	<b>1 620,00</b>	O	O	O	O	O	O	O	O	O	O	O	O	O	O	O	O	O	O	O	O
	<b>DX1</b>	Nasadka dystansowa	<b>4-107426</b>																				
	<b>CF1</b>	Stożek do samochodów dostawczych ø 117÷147 mm	<b>4-107423</b>																				
	<b>CF2</b>	Stożek do samochodów dostawczych 143÷173 mm	<b>4-107424</b>																				
 <p>DX1      CF161</p>	<b>DX1/CF161</b> Professional centring kits for Mercedes Benz Sprinter and Volkswagen Crafter commercial vehicles with central hole with Ø 161 mm.	<b>8-21120004</b>	<b>1 097,00</b>	O	O	O	O	O	O	O	O	O	O	O	O	O	O	O	O	O	O	O	
	<b>DX1</b>	Nasadka dystansowa	<b>4-107426</b>																				
	<b>CF161</b>	Stożek centrujący Ø 161 mm	<b>4-131929</b>																				
<b>NASADKI DYSTANSOWE</b>																							
	<b>DM</b> Nasadka dystansowa Ø 40 mm	<b>8-21100088</b>	<b>335,00</b>	O	O	O	O	O	O	O	O	O	O	O	O	O	O	O	O	O	O	O	
 <p>ARS      DARS</p>	<b>ARS</b> Racing" akcesorium do kół sportowych, do użytku z tuleją wyścigową	<b>8-21100089</b>	<b>1 177,00</b>	O	O	O	O	O	O	O	O	O	O	O	O	O	O	O	O	O	O	O	

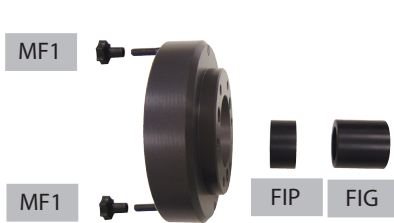
■ = Standard      O = Kompatybilne      - = NIEkompatybilne

# AKCESORIA DO WYWAŻAREK SAMOCHODOWYCH I MOTOCYKLOWYCH

	Opis	Kod	Cena netto	EYE-LIGHT PLUS	EM9980 C PLUS	EM9780 C PLUS	EM9680 C Plus TouchScr	EM9580 Plus TOUCHSCREEN	EM9580 C Plus	EM9580 Plus	EM9550 C Plus	EM9550 Plus	EM9380 C / TOUCHSCREEN	EM9380 / TOUCHSCREEN	EM9350 C	EM9350	EM9280 C	EM9280	EM9250 C PREMIUM	EM9250 PREMIUM	EM9250 PROFESSIONAL	EM9250 Basic	EM9250 Basic BiKLine							
<b>NASADKI DYSTANSOWE</b>																														
	<b>ARF1</b> Specjalna flansa do kół F1 Akcesorium do kół F1 kompatybilne z mocowaniami Ferrari, McLaren i Toyota.	<b>8-21100093</b>	<b>2 749,00</b>	O	O	O	O	O	O	O	O	O	O	O	O	O	O	O	O	O	O	O	O							
	<table border="1"> <tr> <td><b>FIG</b></td> <td>Nasadka dystansowa L=60 mm</td> <td><b>4-105181</b></td> </tr> <tr> <td><b>FIP</b></td> <td>Nasadka dystansowa L=30 mm</td> <td><b>4-105171</b></td> </tr> <tr> <td><b>MF1</b></td> <td>Uchwyt do dystansu F1</td> <td><b>459932</b></td> </tr> </table>	<b>FIG</b>	Nasadka dystansowa L=60 mm	<b>4-105181</b>	<b>FIP</b>	Nasadka dystansowa L=30 mm	<b>4-105171</b>	<b>MF1</b>	Uchwyt do dystansu F1	<b>459932</b>																				
	<b>FIG</b>	Nasadka dystansowa L=60 mm	<b>4-105181</b>																											
	<b>FIP</b>	Nasadka dystansowa L=30 mm	<b>4-105171</b>																											
<b>MF1</b>	Uchwyt do dystansu F1	<b>459932</b>																												
<b>MOCOWANIE KÓŁ - RÓŻNE AKCESORIA</b>																														
	<b>VGBP</b> Koło ręczne do pierścienia mocowania koła.	<b>802260682</b>	<b>429,00</b>	-	-	-	-	O	-	O	-	O	-	O	-	O	-	O	-	O	O	O	O							
	Nasadka <b>CBG</b> do mocowania felg aluminiowych Ø 210 mm	<b>802459564</b>	<b>339,00</b>	O	O	O	O	O	O	O	O	O	O	O	O	O	O	O	O	O	O	O	O							
	<table border="1"> <tr> <td><b>OR</b></td> <td>Elastyczny gumowy pierścień</td> <td><b>462817</b></td> </tr> </table>	<b>OR</b>	Elastyczny gumowy pierścień	<b>462817</b>																										
<b>OR</b>	Elastyczny gumowy pierścień	<b>462817</b>																												
	Szybka blokada <b>QLN</b> . Możliwość montażu we wszystkich modelach z gwintowaną piastą Ø 40 mm. Akcesorium z pistoletem pneumatycznym do mocowania.	<b>8-21100095</b>	<b>2 866,00</b>	-	-	-	-	O	-	O	-	O	-	O	-	O	-	O	-	O	O	O	O							

■ = Standard    O = Kompatybilne    - = NIEkompatybilne



## AKCESORIA DO WYWAŻAREK SAMOCHODOWYCH I MOTOCYKLOWYCH

### FLANSZE DO MOCOWANIA KÓŁ Z OTWOREM CENTRALNYM

Do równomiernego dokręcenia kół, bezpośrednio w otworach montażowych felgi, rozkładając nacisk docisku wokół środkowego otworu tak, jak śruby mocujące koło w pojeździe, dostępne są przednie flansze sworzniowe PPF PREMIUM.

Flansze te są stosowane zamiast zewnętrznej nasadki mocującej i zawsze powinny być dopasowane do stożka centrującego lub tulei centrującej, zapewniając praktycznie bezbłędne centrowanie. Flansze PPF PREMIUM są uniwersalne, intuicyjne i łatwe w obsłudze.

Regulacja PCD jest szybka i może być stosowana do wszystkich typów felg samochodów osobowych, dostawczych i SUV-ów z centralnym otworem, zarówno obecnych, jak i przeszłych.

Wysoka jakość wyników dla każdego wyważania bez poświęcania cennego czasu.

### PRZYKŁAD UŻYCIA

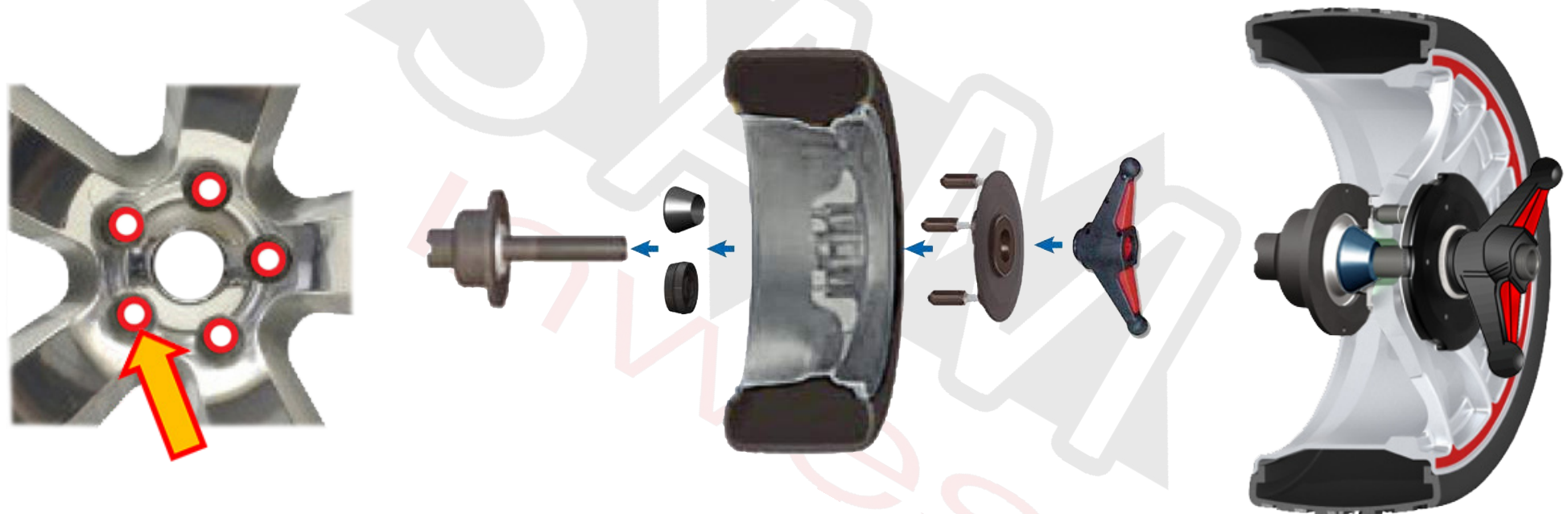

















■ = Standard

○ = Kompatybilne



- = NIEkompatybilne

# AKCESORIA DO WYWAŻAREK SAMOCHODOWYCH I MOTOCYKLOWYCH

Opis	Kod	Cena netto	EYE-LIGHT PLUS	EM9980 C PLUS	EM9780 C PLUS	EM9680 C Plus TOUCHSCR	EM9580 Plus TOUCHSCREEN	EM9580 C Plus	EM9580 Plus	EM9550 C Plus	EM9550 Plus	EM9380 C / TOUCHSCREEN	EM9380 / TOUCHSCREEN	EM9350 C	EM9350	EM9280 C	EM9280	EM9250 C PREMIUM	EM9250 PREMIUM	EM9250 PROFESSIONAL	EM9250 BASIC	EM9250 BASIC BIKE LINE
			FLANSZE DO MOCOWANIA KÓŁ Z OTWOREM CENTRALNYM																			
 <p>per cerchi a 5 fori. Range bloccaggio 95,25 - 180 mm</p> <p>  Ø 28   Ø 22,5   Ø 22,5   Ø 19                 </p>	<p><b>FPF FASTPLATE 5</b> do felg 5-otworowych. Zakres mocowania: 95,25 ÷ 180 mm</p>	8-21100294	2 398,00	0	0	0	0	0	0	0	0	0	0	0	0	0	0	0	0	0	0	0
 <p>per cerchi a 3-4-6-8 fori. Range bloccaggio 95,25 - 180 mm</p> <p>  Ø 28   Ø 22,5   Ø 22,5   Ø 19                 </p>	<p><b>FPF FASTPLATE 3-4-6-8</b> dla 3-4-6-8-otworów felgi. Zakres mocowania: 95,25 ÷ 180 mm</p>	8-21100295	2 704,00	0	0	0	0	0	0	0	0	0	0	0	0	0	0	0	0	0	0	0
 <p>8-21100296 FPF FASTPLATE KIT per cerchi a 3-4-5-6-8 fori. Range bloccaggio 95,25 - 180 mm</p> <p>  Ø 28   Ø 22,5   Ø 22,5   Ø 19                 </p>	<p><b>FPF FASTPLATE KIT</b> Do felg z 3-4-5-6-8 otworami. (zawiera 8-21100294 i 8-21100295)</p>	8-21100296	4 833,00	0	0	0	0	0	0	0	0	0	0	0	0	0	0	0	0	0	0	0
	<p><b>FPF-C SLEEVE HANDLE</b> Tuleja do wyważarek z automatycznym mocowaniem. Do przykręcenia bezpośrednio do FASTPLATE, aby pracować wygodniej i szybciej</p>	8-21100297	421,00	0	0	0	0	-	0	-	0	-	0	-	0	-	0	-	-	-	-	

■ = Standard    O = Kompatybilne    - = NIEkompatybilne

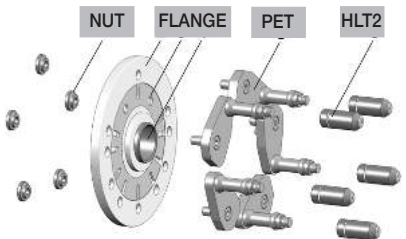
## AKCESORIA DO WYWAŻAREK SAMOCHODOWYCH I MOTOCYKLOWYCH

	Opis	Kod	Cena netto	EYE-LIGHT PLUS	EM9980 C PLUS	EM9780 C PLUS	EM9580 C Plus TouchScr	EM9580 Plus TOUCHSCREEN	EM9580 C Plus	EM9580 Plus	EM9550 C Plus	EM9550 Plus	EM9380 C / TOUCHSCREEN	EM9380 / TOUCHSCREEN	EM9350 C	EM9350	EM9280 C	EM9280	EM9250 C PREMIUM	EM9250 PREMIUM	EM9250 PROFESSIONAL	EM9250 BASIC	EM9250 BASIC BIKELINE
<b>FLANSZE DO MOCOWANIA KÓŁ Z OTWOREM CENTRALNYM</b>																							
	<b>FPF-2 BMW</b> Uniwersalny zestaw flansz do kół z centralnym otworem (Ø 4x100/5x120/5x112).	<b>8-21100145</b>	<b>2 155,00</b>	0	0	0	0	0	0	0	0	0	0	0	0	0	0	0	0	0	0	0	0
	<b>FPF Basic</b> Uniwersalny zestaw flansz do kół z centralnym otworem Ø 40 mm.	<b>8-21100152</b>	<b>2 989,00</b>	0	0	0	0	0	0	0	0	0	0	0	0	0	0	0	0	0	0	0	0
	<b>HLT2</b> Nakładka ø 22,5 L 58	<b>4-109127</b>																					
	<b>PET</b> Podstawowy platek	<b>4-108097</b>																					
	Zestaw z 2 pokrętłami obrotowymi	<b>8-21100291</b>	<b>81,00</b>	-	-	-	-	0	-	0	-	0	-	0	-	0	-	0	-	0	0	0	0

■ = Standard    O = Kompatybilne    - = NIEkompatybilne





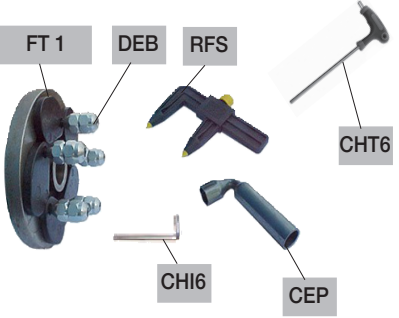
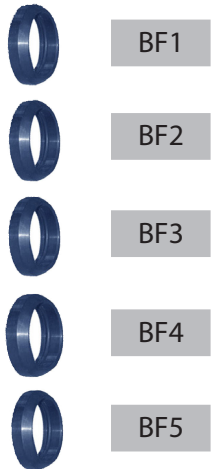

# AKCESORIA DO WYWAŻAREK SAMOCHODOWYCH I MOTOCYKLOWYCH

Opis	Kod	Cena netto	EYE-LIGHT PLUS	EM9980 C PLUS	EM9780 C PLUS	EM9580 C Plus TOUCHSCR	EM9580 Plus TOUCHSCREEN	EM9580 C Plus	EM9580 Plus	EM9550 C Plus	EM9550 Plus	EM9380 C / TOUCHSCREEN	EM9380 / TOUCHSCREEN	EM9350 C	EM9350	EM9280 C	EM9280	EM9250 C PREMIUM	EM9250 PREMIUM	EM9250 PROFESSIONAL	EM9250 BASIC	EM9250 BASIC BIKELINE															
<b>FLANSZE DO MOCOWANIA KÓŁ Z OTWOREM CENTRALNYM I BEZ OTWORU CENTRALNEGO</b>																																					
 <p><b>FRU-SA D.40</b> Flansza uniwersalna do kół z otworem centralnym lub bez.</p>	8-21100091	2 725,00																																			
			<table border="1"> <tr> <td><b>FT 1</b></td> <td>Korbówód ze sworzniem</td> <td><b>4-105873</b></td> </tr> <tr> <td><b>DEB</b></td> <td>Nakrętka stożkowa/kulista do mocowania koła</td> <td><b>321878</b></td> </tr> <tr> <td><b>CHT6</b></td> <td>Chiave esagonale a T CH 6</td> <td><b>4-105877</b></td> </tr> <tr> <td><b>RFS</b></td> <td>Suwmiarka</td> <td><b>441286</b></td> </tr> <tr> <td><b>CEP</b></td> <td>Klucz sześciokątny CH 22</td> <td><b>426517</b></td> </tr> <tr> <td><b>CHI 6</b></td> <td>Klucz sześciokątny CH 6</td> <td><b>600906</b></td> </tr> </table>	<b>FT 1</b>	Korbówód ze sworzniem	<b>4-105873</b>	<b>DEB</b>	Nakrętka stożkowa/kulista do mocowania koła	<b>321878</b>	<b>CHT6</b>	Chiave esagonale a T CH 6	<b>4-105877</b>	<b>RFS</b>	Suwmiarka	<b>441286</b>	<b>CEP</b>	Klucz sześciokątny CH 22	<b>426517</b>	<b>CHI 6</b>	Klucz sześciokątny CH 6	<b>600906</b>																
<b>FT 1</b>	Korbówód ze sworzniem	<b>4-105873</b>																																			
<b>DEB</b>	Nakrętka stożkowa/kulista do mocowania koła	<b>321878</b>																																			
<b>CHT6</b>	Chiave esagonale a T CH 6	<b>4-105877</b>																																			
<b>RFS</b>	Suwmiarka	<b>441286</b>																																			
<b>CEP</b>	Klucz sześciokątny CH 22	<b>426517</b>																																			
<b>CHI 6</b>	Klucz sześciokątny CH 6	<b>600906</b>																																			
 <p><b>BVFF</b> Zestaw 5 tulei do precyzyjnego centrowania na flanszy FRU.</p>	8-21100092	834,00																																			
			<table border="1"> <tr> <td>BF1</td> <td>Tuleja ø 55 Peugeot</td> <td><b>4-105110</b></td> </tr> <tr> <td>BF2</td> <td>Tuleja ø 58,1 Fiat Ritmo and Citroën CX/Evasion, Peugeot 806</td> <td><b>4-105174</b></td> </tr> <tr> <td>BF3</td> <td>Tuleja ø 60,1 Renault</td> <td><b>4-105175</b></td> </tr> <tr> <td>BF4</td> <td>Tuleja ø 65 Peugeot, Citroën</td> <td><b>4-105176</b></td> </tr> <tr> <td>BF5</td> <td>Tuleja ø 57 BMW,VW, AUDI, SEAT</td> <td><b>4-106570</b></td> </tr> </table>	BF1	Tuleja ø 55 Peugeot	<b>4-105110</b>	BF2	Tuleja ø 58,1 Fiat Ritmo and Citroën CX/Evasion, Peugeot 806	<b>4-105174</b>	BF3	Tuleja ø 60,1 Renault	<b>4-105175</b>	BF4	Tuleja ø 65 Peugeot, Citroën	<b>4-105176</b>	BF5	Tuleja ø 57 BMW,VW, AUDI, SEAT	<b>4-106570</b>																			
BF1	Tuleja ø 55 Peugeot	<b>4-105110</b>																																			
BF2	Tuleja ø 58,1 Fiat Ritmo and Citroën CX/Evasion, Peugeot 806	<b>4-105174</b>																																			
BF3	Tuleja ø 60,1 Renault	<b>4-105175</b>																																			
BF4	Tuleja ø 65 Peugeot, Citroën	<b>4-105176</b>																																			
BF5	Tuleja ø 57 BMW,VW, AUDI, SEAT	<b>4-106570</b>																																			

■ = Standard    O = Kompatybilne    - = NIEkompatybilne

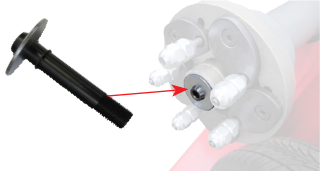

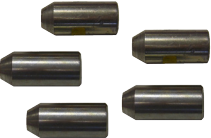

# AKCESORIA DO WYWAŻAREK SAMOCHODOWYCH I MOTOCYKLOWYCH

Opis	Kod	Cena netto	EYE-LIGHT PLUS	EM9980 C PLUS	EM9780 C PLUS	EM9580 C Plus TOUCHSCR	EM9580 Plus TOUCHSCREEN	EM9580 C Plus	EM9580 Plus	EM9550 C Plus	EM9550 Plus	EM9380 C / TOUCHSCREEN	EM9380 / TOUCHSCREEN	EM9350 C	EM9350	EM9280 C	EM9280	EM9250 C PREMIUM	EM9250 PREMIUM	EM9250 PROFESSIONAL	EM9250 BASIC	EM9250 BASIC BikeLINE	
<b>FLANSZE DO MOCOWANIA KÓŁ Z OTWOREM CENTRALNYM I BEZ OTWORU CENTRALNEGO</b>																							
	<b>Tarcza blokująca</b> do tulei BVFF pod flanszę FRU-SA, do wyważarek z dociskiem ręcznym	<b>8-21100207</b>	<b>90,00</b>	-	-	-	-	O	-	O	-	O	-	O	-	O	-	O	-	O	O	O	O
	<b>Tarcza blokująca</b> do tulei BVFF pod flanszę FRU-SA, do wyważarek z automatycznym mocowaniem „C”.	<b>8-21100208</b>	<b>90,00</b>	O	O	O	O	-	O	-	O	-	O	-	O	-	O	-	O	-	-	-	-
	<b>BCO</b> Zestaw pięciu podkładek stożkowych do FRU-sa do stosowania z DCL i DEB przy obróbce otworów o średnicy większej niż 21 mm	<b>802321387</b>	<b>231,00</b>	O	O	O	O	O	O	O	O	O	O	O	O	O	O	O	O	O	O	O	O
	<b>DCL</b> Zestaw pięciu nakrętek stożkowych do felg aluminiowych z kołnierzem FRU-SA.	<b>802322075</b>	<b>377,00</b>	O	O	O	O	O	O	O	O	O	O	O	O	O	O	O	O	O	O	O	O
	<b>DMS</b> Zestaw pięciu nakrętek kulistych do felg aluminiowych z kołnierzem FRU-SA.	<b>802322076</b>	<b>377,00</b>	O	O	O	O	O	O	O	O	O	O	O	O	O	O	O	O	O	O	O	O

■ = Standard    O = Kompatybilne    - = NIEkompatybilne







## AKCESORIA DO WYWAŻAREK SAMOCHODOWYCH I MOTOCYKLOWYCH

	Opis	Kod	Cena netto	EYE-LIGHT PLUS	EM9980 C PLUS	EM9780 C PLUS	EM9580 C Plus TouchScr	EM9580 Plus TouchSCREEN	EM9580 C Plus	EM9580 Plus	EM9550 C Plus	EM9550 Plus	EM9380 C / TOUCHSCREEN	EM9380 / TOUCHSCREEN	EM9350 C	EM9350	EM9280 C	EM9280	EM9250 C PREMIUM	EM9250 PREMIUM	EM9250 PROFESSIONAL	EM9250 BASIC	EM9250 BASIC BIKELINE	
	<b>DC5</b> Zestaw pięciu specjalnych nakrętek do Citroena C5.	<b>802262700</b>	<b>377,00</b>	O	O	O	O	O	O	O	O	O	O	O	O	O	O	O	O	O	O	O	O	O
	<b>SDR</b> Zestaw pięciu specjalnych nakrętek do szybkiego mocowania kół.	<b>802231479</b>	<b>1 365,00</b>	O	O	O	O	O	O	O	O	O	O	O	O	O	O	O	O	O	O	O	O	O

■ = Standard    O = Kompatybilne    - = NIEkompatybilne

# AKCESORIA DO WYWAŻAREK SAMOCHODOWYCH I MOTOCYKLOWYCH

Opis	Kod	Cena netto	EYE-LIGHT PLUS	EM9980 C PLUS	EM9780 C PLUS	EM9580 C Plus TouchScr	EM9580 Plus TouchSCREEN	EM9580 C Plus	EM9580 Plus	EM9550 C Plus	EM9550 Plus	EM9380 C / TOUCHSCREEN	EM9380 / TOUCHSCREEN	EM9350 C	EM9350	EM9280 C	EM9280	EM9250 C PREMIUM	EM9250 PREMIUM	EM9250 PROFESSIONAL	EM9250 BASIC	EM9250 BASIC BIKELINE
			<b>SYSTEM KALIBRACJI I WSPARCIA TECHNICZNEGO</b>																			
	Kalibracja lasera <b>BLCK-1</b> dla EM9980-C Plus, Eyclight Plus, EM9780 Plus	8-21120001	0	0	0	-	-	-	-	-	-	-	-	-	-	-	-	-	-	-	-	-
	Kabel szeregowy <b>RS232</b> (mbu - mbe - seb).	8-21100224	137,00	0	0	0	0	0	0	0	0	0	0	0	0	0	0	0	0	0	0	0
	<b>Adapter USB-RS232.</b>	8-21100226	203,00	0	0	0	0	0	0	0	0	0	0	0	0	0	0	0	0	0	0	0
	<b>SLUG</b> próbka masy do kalibracji.	8-21100221	326,00	■	■	■	■	■	■	■	■	■	■	■	■	■	■	■	■	■	■	■
	<b>Zestaw narzędzi.</b>	8-21100197	420,00	0	0	0	0	0	0	0	0	0	0	0	0	0	0	0	0	0	0	0

■ = Standard    O = Kompatybilne    - = NIEkompatybilne

## AKCESORIA DO WYWAŻAREK SAMOCHODOWYCH I MOTOCYKLOWYCH

### AKCESORIA CENTRUJĄCE I MOCUJĄCE DO KÓŁ MOTOCYKLOWYCH

W gamie akcesoriów do wyważarek terenowych dostępny jest nowy BIKES UNIVERSAL KIT z różnymi dodatkowymi zestawami do centrowania i dynamicznego wyważania kół motocyklowych. Łatwy w instalacji i szybki w użyciu. Idealny do małych kół do skuterów o średnicy do 21 cali typu terenowego; nie zapominając o szerokim chopperze i monoleverach bez łożysk. Wyniki wyważania doskonałe!

Uniwersalna do wszystkich wyważarek w zakresie mocowania ręcznego i automatycznego.

### PRZYKŁAD UŻYCIA



Wał ze stożkami centrującymi.



Wał z tulejami centrującymi.



Wał motocykla o tej samej średnicy co łożysko pływające.

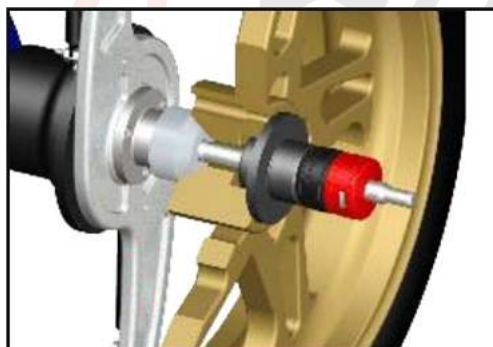

Wał ze specjalnym zestawem centrującym.

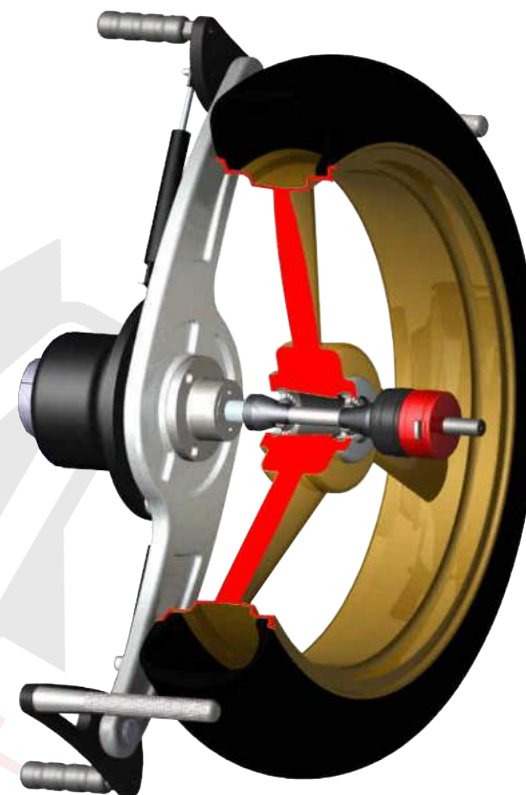

■ = Standard

○ = Kompatybilne

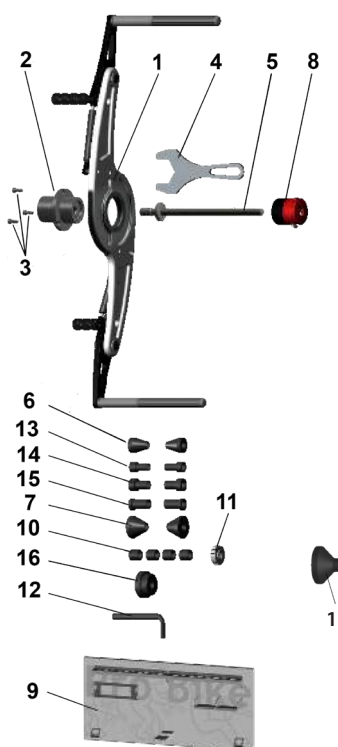
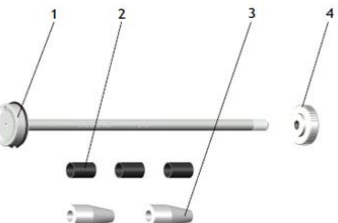

- = NIEkompatybilne

# AKCESORIA DO WYWAŻAREK SAMOCHODOWYCH I MOTOCYKLOWYCH

Opis	Kod	Cena netto	EYE-LIGHT PLUS	EM9980 C PLUS	EM9780 C PLUS	EM9580 C Plus TOUCHSCR	EM9580 Plus TOUCHSCREEN	EM9580 C Plus	EM9580 Plus	EM9550 C Plus	EM9550 Plus	EM9380 C / TOUCHSCREEN	EM9380 / TOUCHSCREEN	EM9350 C	EM9350	EM9280 C	EM9280	EM9250 C PREMIUM	EM9250 PREMIUM	EM9250 PROFESSIONAL	EM9250 BASIC	EM9250 Basic BikeLine	
<b>STANDARDOWE AKCESORIA MOTOCYKLOWE</b>																							
	<b>BIKE UNIVERSAL KIT</b> 8-21120012 Podstawowe urządzenie do wyważania kół motocykli i skuterów. Wał uchwyty koła 14 mm. * Wskaźnik przedłużenia motocykla NIE jest wliczony w cenę	4 310,00	○	○	○	○	○	○	○	○	○	○	○	○	○	○	○	○	○	○	○	■	
	1	GRUPA PRZECIĄGAJĄCA	3-03408																				
	2	UCHWYT CYLINDRYCZNY	3-03409																				
	3	ŚRUBA Z GNIAZDEM SZEŚCIOKĄTNYM M 6X14	3-03410																				
	4	KLUCZ JEDNOGŁÓWKOWY SW50	3-03411																				
	5	WAŁ UCHWYTU KOŁA Ø 14 MM	3-03412																				
	6	STOŻEK CENTRUJĄCY 15÷30 MM	3-03413																				
	7	STOŻEK CENTRUJĄCY 16÷45 MM	3-03414																				
	8	SZYBKIE MOCOWANIE DO TRZPIENIA Ø 14 MM	3-03415																				
	9	PLYTA ŚCIENNA	3-03416																				
	10	KRÓTKI DYSTANS	3-03417																				
	11	M 14 NAKRĘTKA radełkowana	3-03418																				
	12	KLUCZ Z GNIAZDEM SZEŚCIOKĄTNYM SW4	3-03419																				
	13	TULEJA CENTRUJĄCA Ø 15 MM	3-03420																				
	14	TULEJA CENTRUJĄCA Ø 17 MM	3-03421																				
	15	TULEJA CENTRUJĄCA Ø 20 MM	3-03422																				
	16	TULEJA CENTRUJĄCA PIAGGIO	3-03423																				
17	CIŚNIENIE BMW/HONDA	3-03407																					
	Ø10mm <b>Wałek centrujący</b> extra-długi 230mm, do ewentualnego uzupełnienia kodu 8-21120012 8-21100257	1 107,00	○	○	○	○	○	○	○	○	○	○	○	○	○	○	○	○	○	○	○	○	
	1	WAŁ Ø 10 MM	3-03864																				
	2	SPACER	3-03865																				
	3	CENTERING CONE D. 12÷20 MM	3-03866																				
4	RING NUT M 10	3-03867																					

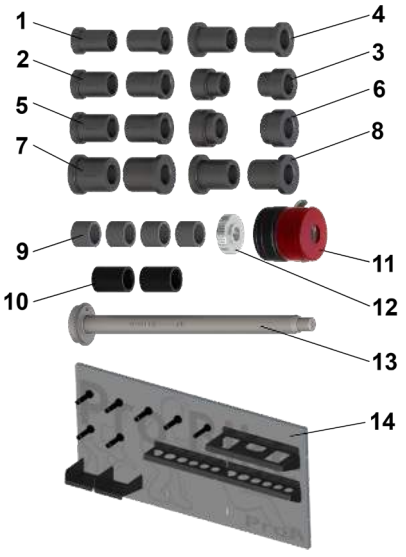

■ = Standard    ○ = Kompatybilne    - = NIEkompatybilne

# AKCESORIA DO WYWAŻAREK SAMOCHODOWYCH I MOTOCYKLOWYCH

	Opis	Kod	Cena netto	EYE-LIGHT PLUS	EM9980 C PLUS	EM9780 C PLUS	EM9580 C Plus TouchScr	EM9580 Plus TouchSCREEN	EM9580 C Plus	EM9580 Plus	EM9550 C Plus	EM9550 Plus	EM9380 C / TouchSCREEN	EM9380 / TouchSCREEN	EM9350 C	EM9350	EM9280 C	EM9280	EM9250 C PREMIUM	EM9250 PREMIUM	EM9250 PROFESSIONAL	EM9250 BASIC	EM9250 BASIC BikeLINE																																									
<b>STANDARDOWE AKCESORIA MOTOCYKLOWE</b>																																																																
	<b>PRA3</b> Motocyklowe przedłużenie czujnika. <u>Do modeli z klipsem.</u>	<b>8-21100116</b>	<b>495,00</b>	-	-	-	O	O	O	O	O	O	O	O	O	O	O	O	O	O	O	O	O																																									
	<b>PRA4</b> Motocyklowe przedłużenie czujnika. <u>Do modeli bez klipsa.</u>	<b>8-21100155</b>	<b>495,00</b>	-	-	-	-	-	-	-	-	-	O	O	O	O	O	O	O	O	O	O	■																																									
	<b>BIKE UPGRADE KIT 19</b> Dodatkowy moduł do BIKE UNIVERSAL KIT.	<b>8-21120013</b>	<b>2 523,00</b>	O	O	O	O	O	O	O	O	O	O	O	O	O	O	O	O	O	O	O	O																																									
	<table border="1"> <tbody> <tr> <td>1</td> <td>TULEJA CENTRUJĄCA D. 22 mm</td> <td>3-03383</td> </tr> <tr> <td>2</td> <td>TULEJA CENTRUJĄCA D. 25,4 mm</td> <td>3-03384</td> </tr> <tr> <td>3</td> <td>TULEJA CENTRUJĄCA D. 25 mm</td> <td>3-03385</td> </tr> <tr> <td>4</td> <td>TULEJA CENTRUJĄCA D. 26 mm</td> <td>3-03386</td> </tr> <tr> <td>5</td> <td>TULEJA CENTRUJĄCA D. 28 mm</td> <td>3-03387</td> </tr> <tr> <td>6</td> <td>TULEJA CENTRUJĄCA D. 32 mm</td> <td>3-03388</td> </tr> <tr> <td>7</td> <td>TULEJA CENTRUJĄCA D. 35 mm</td> <td>3-03389</td> </tr> <tr> <td>8</td> <td>TULEJA CENTRUJĄCA D. 30 mm</td> <td>3-03390</td> </tr> <tr> <td>9</td> <td>KRÓTKI DYSTANS Śr. 20 mm</td> <td>3-03391</td> </tr> <tr> <td>10</td> <td>HARLEY D. PRZEŁĄCZNIK CIŚNIENIA</td> <td>3-03392</td> </tr> <tr> <td>11</td> <td>SZYBKE MOCOWANIE DO WAŁU D. 19</td> <td>3-03393</td> </tr> <tr> <td>12</td> <td>M 14 NAKRĘTKA radełkowana</td> <td>3-03418</td> </tr> <tr> <td>13</td> <td>WAŁ UCHWYTU KOŁA Śr. 19 mm</td> <td>3-03396</td> </tr> <tr> <td>14</td> <td>PŁYTA ŚCIENNA</td> <td>3-03395</td> </tr> </tbody> </table>	1	TULEJA CENTRUJĄCA D. 22 mm	3-03383	2	TULEJA CENTRUJĄCA D. 25,4 mm	3-03384	3	TULEJA CENTRUJĄCA D. 25 mm	3-03385	4	TULEJA CENTRUJĄCA D. 26 mm	3-03386	5	TULEJA CENTRUJĄCA D. 28 mm	3-03387	6	TULEJA CENTRUJĄCA D. 32 mm	3-03388	7	TULEJA CENTRUJĄCA D. 35 mm	3-03389	8	TULEJA CENTRUJĄCA D. 30 mm	3-03390	9	KRÓTKI DYSTANS Śr. 20 mm	3-03391	10	HARLEY D. PRZEŁĄCZNIK CIŚNIENIA	3-03392	11	SZYBKE MOCOWANIE DO WAŁU D. 19	3-03393	12	M 14 NAKRĘTKA radełkowana	3-03418	13	WAŁ UCHWYTU KOŁA Śr. 19 mm	3-03396	14	PŁYTA ŚCIENNA	3-03395																					
1	TULEJA CENTRUJĄCA D. 22 mm	3-03383																																																														
2	TULEJA CENTRUJĄCA D. 25,4 mm	3-03384																																																														
3	TULEJA CENTRUJĄCA D. 25 mm	3-03385																																																														
4	TULEJA CENTRUJĄCA D. 26 mm	3-03386																																																														
5	TULEJA CENTRUJĄCA D. 28 mm	3-03387																																																														
6	TULEJA CENTRUJĄCA D. 32 mm	3-03388																																																														
7	TULEJA CENTRUJĄCA D. 35 mm	3-03389																																																														
8	TULEJA CENTRUJĄCA D. 30 mm	3-03390																																																														
9	KRÓTKI DYSTANS Śr. 20 mm	3-03391																																																														
10	HARLEY D. PRZEŁĄCZNIK CIŚNIENIA	3-03392																																																														
11	SZYBKE MOCOWANIE DO WAŁU D. 19	3-03393																																																														
12	M 14 NAKRĘTKA radełkowana	3-03418																																																														
13	WAŁ UCHWYTU KOŁA Śr. 19 mm	3-03396																																																														
14	PŁYTA ŚCIENNA	3-03395																																																														

■ = Standard    O = Kompatybilne    - = NIEkompatybilne

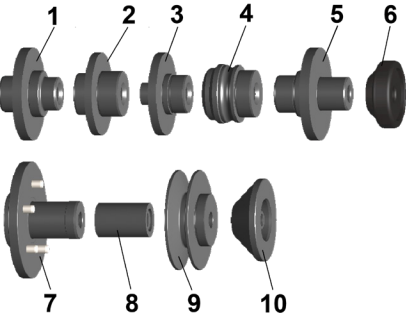
# AKCESORIA DO WYWAŻAREK SAMOCHODOWYCH I MOTOCYKLOWYCH

Opis	Kod	Cena netto	EYE-LIGHT PLUS	EM9980 C PLUS	EM9780 C PLUS	EM9580 C Plus TouchScr	EM9580 Plus TouchSCREEN	EM9580 C Plus	EM9580 Plus	EM9550 C Plus	EM9550 Plus	EM9380 C / TOUCHSCREEN	EM9380 / TOUCHSCREEN	EM9350 C	EM9350	EM9280 C	EM9280	EM9250 C PREMIUM	EM9250 PREMIUM	EM9250 PROFESSIONAL	EM9250 BASIC	EM9250 BASIC BikeLine																														
			STANDARDOWE AKCESORIA MOTOCYKLOWE																																																	
 <p><b>BIKE MONOLEVER KIT 19</b> Dodatkowy moduł do zestawu BIKE UPGRADE KIT do kół motocyklowych z monoleverem.</p> <table border="1"> <tr> <td>1</td> <td>TULEJA CENTRUJĄCA DUCATI/TRIUMPH</td> <td>3-03397</td> </tr> <tr> <td>2</td> <td>TULEJA CENTRUJĄCA MV AGUSTA/HONDA</td> <td>3-03398</td> </tr> <tr> <td>3</td> <td>TULEJA CENTRUJĄCA HONDA GL 1800 / NTV 650</td> <td>3-03399</td> </tr> <tr> <td>4</td> <td>TULEJA CENTRUJĄCA APRILIA/BMW/YAMAHA</td> <td>3-03400</td> </tr> <tr> <td>5</td> <td>TULEJA CENTRUJĄCA TRIUMPH/HONDA VFR1200</td> <td>3-03401</td> </tr> <tr> <td>6</td> <td>CZĘŚĆ CIŚNIENIA</td> <td>3-03402</td> </tr> <tr> <td>7</td> <td>FLANSA CENTRUJĄCA KTM SUPERDUKE+TRIUMPH</td> <td>3-03403</td> </tr> <tr> <td>8</td> <td>TULEJA DYSTANSOWA, DŁUGA</td> <td>3-03404</td> </tr> <tr> <td>9</td> <td>TARCZA CENTRUJĄCA BMW II (OD ROKU PRODUKCJI 2005) RÓWNIEŻ R V1200 GS</td> <td>3-03405</td> </tr> <tr> <td>10</td> <td>TARCZA CENTRUJĄCA BMW I (OD ROKU PRODUKCJI 2005) APART R V1200 GS, MOTO GUZZI (OD 2008 ROKU) (Ø WEWNĘTRZNA 14)</td> <td>3-03406</td> </tr> </table>	1	TULEJA CENTRUJĄCA DUCATI/TRIUMPH	3-03397	2	TULEJA CENTRUJĄCA MV AGUSTA/HONDA	3-03398	3	TULEJA CENTRUJĄCA HONDA GL 1800 / NTV 650	3-03399	4	TULEJA CENTRUJĄCA APRILIA/BMW/YAMAHA	3-03400	5	TULEJA CENTRUJĄCA TRIUMPH/HONDA VFR1200	3-03401	6	CZĘŚĆ CIŚNIENIA	3-03402	7	FLANSA CENTRUJĄCA KTM SUPERDUKE+TRIUMPH	3-03403	8	TULEJA DYSTANSOWA, DŁUGA	3-03404	9	TARCZA CENTRUJĄCA BMW II (OD ROKU PRODUKCJI 2005) RÓWNIEŻ R V1200 GS	3-03405	10	TARCZA CENTRUJĄCA BMW I (OD ROKU PRODUKCJI 2005) APART R V1200 GS, MOTO GUZZI (OD 2008 ROKU) (Ø WEWNĘTRZNA 14)	3-03406	8-21120014	3 887,00	○	○	○	○	○	○	○	○	○	○	○	○	○	○	○	○	○	○	○	○
	1	TULEJA CENTRUJĄCA DUCATI/TRIUMPH	3-03397																																																	
	2	TULEJA CENTRUJĄCA MV AGUSTA/HONDA	3-03398																																																	
	3	TULEJA CENTRUJĄCA HONDA GL 1800 / NTV 650	3-03399																																																	
	4	TULEJA CENTRUJĄCA APRILIA/BMW/YAMAHA	3-03400																																																	
	5	TULEJA CENTRUJĄCA TRIUMPH/HONDA VFR1200	3-03401																																																	
	6	CZĘŚĆ CIŚNIENIA	3-03402																																																	
	7	FLANSA CENTRUJĄCA KTM SUPERDUKE+TRIUMPH	3-03403																																																	
	8	TULEJA DYSTANSOWA, DŁUGA	3-03404																																																	
	9	TARCZA CENTRUJĄCA BMW II (OD ROKU PRODUKCJI 2005) RÓWNIEŻ R V1200 GS	3-03405																																																	
	10	TARCZA CENTRUJĄCA BMW I (OD ROKU PRODUKCJI 2005) APART R V1200 GS, MOTO GUZZI (OD 2008 ROKU) (Ø WEWNĘTRZNA 14)	3-03406																																																	
 <p><b>Ø14mm Wałek centrujący</b> extra-długi 318mm, do ewentualnego uzupełnienia kodu 8-21120012</p>	8-21120016	1 512,00	○	○	○	○	○	○	○	○	○	○	○	○	○	○	○	○	○	○	○	○																														
 <p><b>Ø19mm Wałek centrujący</b> extra-długi 365mm, do ewentualnego uzupełnienia kodu 8-21120013</p>	8-21120017	1 647,00	○	○	○	○	○	○	○	○	○	○	○	○	○	○	○	○	○	○	○	○																														

■ = Standard    ○ = Kompatybilne    - = NIEkompatybilne



www.corgi.pl



## EM 9050 SPACESAVER



### STANDARDOWE AKCESORIA



Ø 42÷103,5 mm



x3



DLA WERSJI  
HAND SPIN



DLA WERSJI Z  
NAPEŁDEM



Kod	Zasilanie	Opis	Cena netto
0-21109051/16	200-230V/1Ph/50-60Hz	<b>EM 9050 SPACESAVER - HAND SPIN</b> Przenośna wyważarka do opon samochodowych o niewielkich wymiarach i wadze; specjalnie zaprojektowane do obsługi mobilnej i warsztatów o ograniczonej przestrzeni roboczej. Ręczna wersja. Automatyczne wykrywanie rozmiaru kół SmartArm 28". Hamulec obsługiwany dźwignią.	11 650,00
0-21109050/16	200-230V/1Ph/50-60Hz	<b>EM 9050 SPACESAVER - MOTORIZED</b> Przenośna wyważarka do opon samochodowych, kompaktowa pod względem wymiarów i wagi; specjalnie zaprojektowane do obsługi mobilnej i warsztatów o ograniczonej przestrzeni roboczej. Wersja z napędem elektrycznym uruchamiana dźwignią. Automatyczne wykrywanie rozmiarów kół SmartArm 28". Hamulec obsługiwany dźwignią.	12 995,00

**ODLICZ OD CENY -15 % RABATU**

## EM 9050 - TILT UP - HAND SPIN



### STANDARDOWE AKCESORIA



Kod	Zasilanie	Opis	Cena netto
0-21109052/16	200-230V/1Ph/50-60Hz	<b>EM9050 SPACESAVER - TILT UP - HAND SPIN</b> Specjalna wersja do obsługi mobilnej. Idealny do pracy wewnątrz furgonetki dzięki możliwości odchylenia jednostki pomiarowej do pozycji pionowej. Wersja z ręcznym obrotem, automatyczne wykrywanie rozmiaru kół SmartArm. Hamulec obsługiwany dźwignią.	<b>12 995,00</b>

**ODLICZ OD CENY -15 % RABATU**

## EM 9050 - SLIDE - Motorized Spin



### STANDARDOWE AKCESORIA



Kod	Zasilanie	Opis	Cena netto
0-21109053/16	200-230V/1P <sub>H</sub> /50-60Hz	<b>EM 9050 SPACESAVER - SLIDE - MOTORIZED</b> Specjalna wersja do obsługi mobilnej. Można go wyjąć z bocznych drzwi i umożliwić wygodną pracę poza furgonetką. Wersja z napędem silnikowym uruchamiana dźwignią, automatyczne wykrywanie rozmiaru kół SmartArm. Hamulec obsługiwany dźwignią.	<b>15 342,00</b>

**ODLICZ OD CENY -15 % RABATU**

## EM 9050 WORKBENCH



### STANDARDOWE AKCESORIA



DLA WERSJI  
HAND SPIN

Ø 42÷103,5 mm

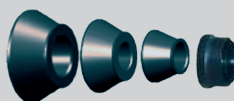

x3







DLA WERSJI Z  
NAPĘDEM



Kod	Zasilanie	Opis	Cena netto
0-21109057/16	100÷230/1P <sub>H</sub> /50-60Hz	<b>EM9050 WORKBENCH - Hand Spin.</b> Niezwykle kompaktowa wyważarka do kół. Można ją przymocować do stołu warsztatowego. Dla hobbystów, małych warsztatów lub do serwisu mobilnego. Automatyczne wykrywanie rozmiaru koła SmartArm 28". Hamulec sterowany dźwignią. Wersja ręczna.	11 203,00
0-21109056/16	200÷230/1P <sub>H</sub> /50-60Hz	<b>EM9050 WORKBENCH - Motorized Spin.</b> Niezwykle kompaktowa wyważarka do kół. Można ją przymocować do stołu warsztatowego. Dla hobbystów, małych warsztatów lub serwisu mobilnego. Automatyczne wykrywanie rozmiaru koła SmartArm 28". Hamulec sterowany dźwignią. Wersja z napędem silnikowym uruchamiana dźwignią	12 445,00

**ODLICZ OD CENY -15 % RABATU**

## ZALECANE AKCESORIA DO SERWISU MOBILNEGO

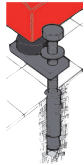
	Opis	Kod	Cena netto	EM 9050 HS	EM 9050 Motor	EM 9050 Tilt	EM 9050 Slide	EM 9050 WB HS	EM 9050 WB Motor
	PL - idealna stopa do montażu bez kotwienia do podłoża; dostępny w kolorze czerwonym (/16) i szarym (/90) (nie dotyczy wersji EM9050 SLIDE)	8-21101100/XX	420,00	O	O	O	-	-	-
	Wózek ułatwiający obsługę (nie dotyczy wersji EM9050 SLIDE)	8-21101200	284,00	O	O	O	-	-	-
	AL12 - zestaw zasilacza 12v (tylko dla wersji EM9050 Hand Spin)	8-21101000	396,00	O	-	O	-	O	-
	Zestaw TILT do uzyskania wersji TILT; Idealny do pracy wewnątrz samochodu dostawczego dzięki możliwości pochYLENIA jednostki pomiarowej do pozycji pionowej	8-21101300	1 375,00	O	O	-	-	-	-
	Zestaw KFTU — zestaw do mocowania do podłogi (dostarczany już z EM9050 Hand Spin, EM 9050 Motorized Spin, EM 9050 TILT UP)	8-21101010	246,00	■	■	■	-	-	-

■ = Standard    O = Kompatybilne    - = NIEkompatybilne

## ZALECANE AKCESORIA DO SERWISU MOBILNEGO

	Opis	Kod	Cena netto	EM 9050 HS	EM 9050 Motor	EM 9050 Tilt	EM 9050 Slide	EM 9050 WB HS	EM 9050 WB Motor																		
	<b>ARF</b> Akcesorium do kół terenowych Ø 102,5÷118,5 mm.	<b>8-21100080</b>	<b>500,00</b>	O	O	O	O	O	O																		
	<b>MLC</b> Obrót uchwyty do flanszy FRU-SA	<b>802244344</b>	<b>170,00</b>	O	-	O	-	O	-																		
	<b>DX/CBF</b> Akcesorium centrujące do samochodów dostawczych i terenowych Ø 117÷173 mm. <table border="1" style="width: 100%; border-collapse: collapse;"> <tr> <td style="width: 10%;">DX1</td> <td style="width: 70%;">Nasadka dystansowa</td> <td style="width: 20%;">4-107426</td> </tr> <tr> <td>CF1</td> <td>Stożek do samochodów dostawczych ø 117÷147 mm</td> <td>4-107423</td> </tr> <tr> <td>CF2</td> <td>Stożek do samochodów dostawczych ø 143÷173 mm</td> <td>4-107424</td> </tr> </table>	DX1	Nasadka dystansowa	4-107426	CF1	Stożek do samochodów dostawczych ø 117÷147 mm	4-107423	CF2	Stożek do samochodów dostawczych ø 143÷173 mm	4-107424	<b>8-21100141</b>	<b>1 620,00</b>	O	O	O	O	O	O									
DX1	Nasadka dystansowa	4-107426																									
CF1	Stożek do samochodów dostawczych ø 117÷147 mm	4-107423																									
CF2	Stożek do samochodów dostawczych ø 143÷173 mm	4-107424																									
	<b>SBC</b> Zestaw sześciu tulei centrujących ø 40 mm. <table border="1" style="width: 100%; border-collapse: collapse;"> <tr> <td style="width: 10%;"><b>B1</b></td> <td style="width: 70%;">AUDI, BMW, Chrysler, Opel, Rover, Seat, VW, Daewoo, Galaxy (Ford), Lotus, British-Leyland, Smart (Mercedes), Skoda</td> <td style="width: 20%;">4-105075</td> </tr> <tr> <td><b>B2</b></td> <td>Citröen, Hyundai, Lancia, Maserati, Mazda, Mercedes, Mitsubishi, Nissan, Opel, Peugeot, Saab, Volvo.</td> <td>4-105076</td> </tr> <tr> <td><b>B3</b></td> <td>BMW, Jaguar, Aston Martin.</td> <td>4-105077</td> </tr> <tr> <td><b>B4</b></td> <td>Ford, Honda, Rover</td> <td>4-105078</td> </tr> <tr> <td><b>B5</b></td> <td>Autobianchi, Alfa Romeo, Citröen, Fiat, Lada, Lancia, Jalbot, Biturbo (Maserati), Mazda, Nissan, Peugeot, Porsche, Renault, 2600-3500 serie (Rover), Seat =&gt;90, Skoda, Toyota.</td> <td>4-105079</td> </tr> <tr> <td><b>B7</b></td> <td>Citröen, Daihatsu, Honda, Kia, Mazda, Mitsubishi, Peugeot, Rover, Subaru, Toyota, Agila (Opel), Suzuki, Hyuday.</td> <td>4-105080</td> </tr> </table>	<b>B1</b>	AUDI, BMW, Chrysler, Opel, Rover, Seat, VW, Daewoo, Galaxy (Ford), Lotus, British-Leyland, Smart (Mercedes), Skoda	4-105075	<b>B2</b>	Citröen, Hyundai, Lancia, Maserati, Mazda, Mercedes, Mitsubishi, Nissan, Opel, Peugeot, Saab, Volvo.	4-105076	<b>B3</b>	BMW, Jaguar, Aston Martin.	4-105077	<b>B4</b>	Ford, Honda, Rover	4-105078	<b>B5</b>	Autobianchi, Alfa Romeo, Citröen, Fiat, Lada, Lancia, Jalbot, Biturbo (Maserati), Mazda, Nissan, Peugeot, Porsche, Renault, 2600-3500 serie (Rover), Seat =>90, Skoda, Toyota.	4-105079	<b>B7</b>	Citröen, Daihatsu, Honda, Kia, Mazda, Mitsubishi, Peugeot, Rover, Subaru, Toyota, Agila (Opel), Suzuki, Hyuday.	4-105080	<b>8-21100082</b>	<b>1 243,00</b>	O	O	O	O	O	O
<b>B1</b>	AUDI, BMW, Chrysler, Opel, Rover, Seat, VW, Daewoo, Galaxy (Ford), Lotus, British-Leyland, Smart (Mercedes), Skoda	4-105075																									
<b>B2</b>	Citröen, Hyundai, Lancia, Maserati, Mazda, Mercedes, Mitsubishi, Nissan, Opel, Peugeot, Saab, Volvo.	4-105076																									
<b>B3</b>	BMW, Jaguar, Aston Martin.	4-105077																									
<b>B4</b>	Ford, Honda, Rover	4-105078																									
<b>B5</b>	Autobianchi, Alfa Romeo, Citröen, Fiat, Lada, Lancia, Jalbot, Biturbo (Maserati), Mazda, Nissan, Peugeot, Porsche, Renault, 2600-3500 serie (Rover), Seat =>90, Skoda, Toyota.	4-105079																									
<b>B7</b>	Citröen, Daihatsu, Honda, Kia, Mazda, Mitsubishi, Peugeot, Rover, Subaru, Toyota, Agila (Opel), Suzuki, Hyuday.	4-105080																									
	<b>VGBP</b> Uchwyt do nakrętki koła	<b>802260682</b>	<b>429,00</b>	O	■	O	■	O	■																		

■ = Standard    O = Kompatybilne    - = NIEkompatybilne

## ZALECANE AKCESORIA DO SERWISU MOBILNEGO

	Opis	Kod	Cena netto	EM 9050 HS	EM 9050 Motor	EM 9050 Tilt	EM 9050 Slide	EM 9050 WB HS	EM 9050 WB Motor
	<b>WYKRYWANIE ROZMIARÓW KOŁA</b> cyfrowy miernik do pozyskiwania średnicy i odległości. Maksymalna precyzja przy wykorzystaniu systemu FSP, który automatycznie dobiera odpowiedni program wyważania.	8-21120022	975,00	0	0	0	0	0	0

SAMINWEST

■ = Standard    ○ = Kompatybilne    - = NIEkompatybilne



SAMINWEST

ul. Rybnicka 77a, 44-285 Rzuchów

tel.: 32-430-10-62

saminwest@saminwest.com

www.corghi.pl

**PIERWSZY AUTORYZOWANY PRZEDSTAWICIEL MARKI CORGHI NIEPRZERWANIE OD 30LAT**

